

232.01 [9 9/64]

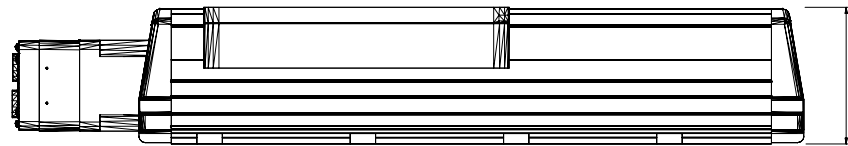

105.40 [4 5/32]

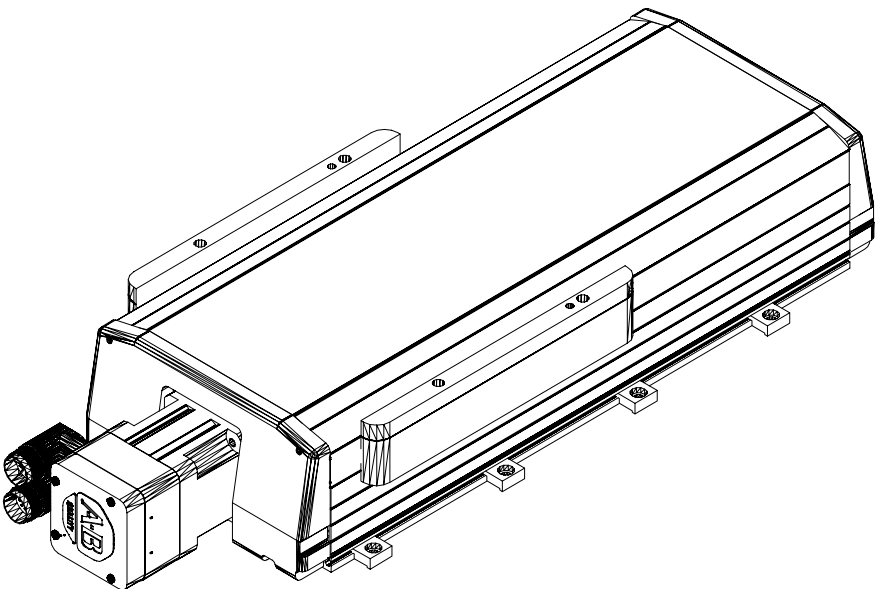

MPAS-A80181-V05S2A  
MP Linear Stage, Frame  
200, 230v, 180mm Stroke  
Length, Multi-turn,  
05mm Screw Lead, with  
Cover