

232.01 [9 9/64]

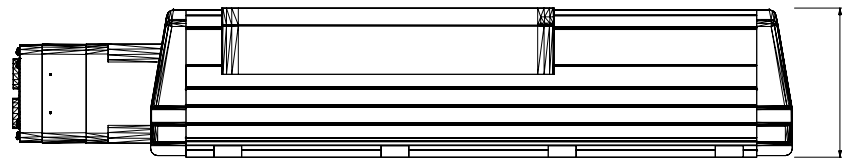

105.40 [4 5/32]

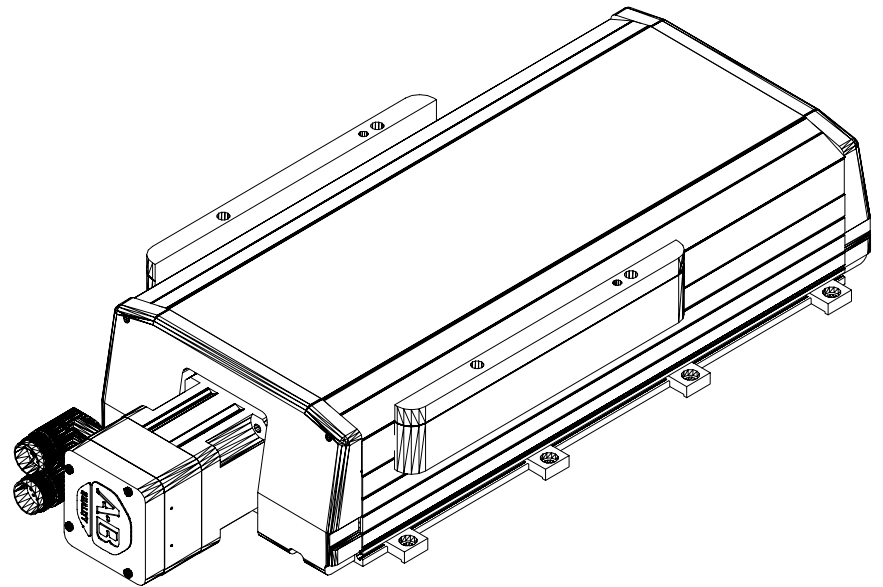

MPAS-A80121-V05S2A
MP Linear Stage, Frame
200, 230v, 120mm Stroke
Length, Multi-turn,
05mm Screw Lead, with
Cover