

232.01 [9 9/64]

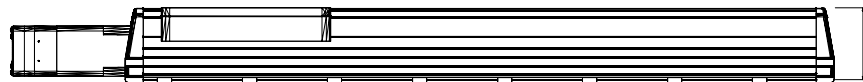

100.28 [3 61/64]

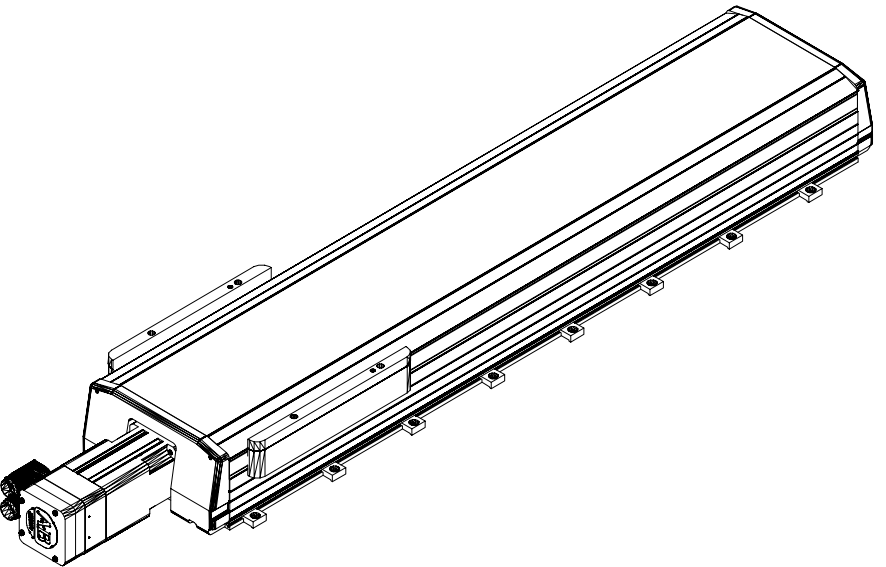

MPAS-B80662-V20S4A
MP Linear Stage, Frame
200, 460v, 660mm Stroke
Length, Multi-turn, 20mm
Screw Lead, with Cover
and Brake