

232.01 [9 9/64]

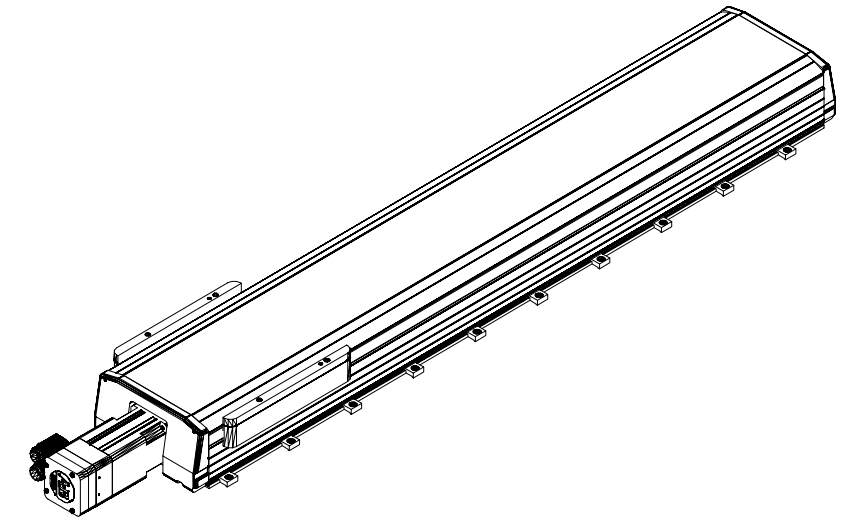

105.40 [4 5/32]



MPAS-A80902-V20S4A
MP Linear Stage, Frame
200, 230v, 900mm Stroke
Length, Multi-turn,
20mm Screw Lead, with
Cover and Brake