

232.01 [9 9/64]

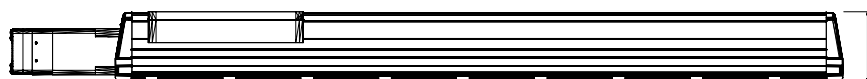

105.40 [4 5/32]

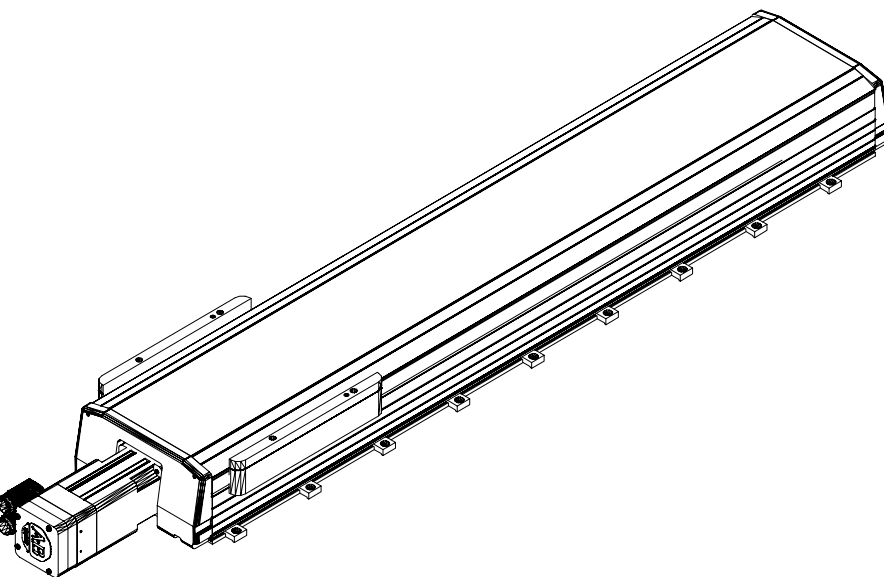

MPAS-A80782-V20S4A
MP Linear Stage, Frame
200, 230v, 780mm Stroke
Length, Multi-turn, 20mm
Screw Lead, with Cover
and Brake