

232.01 [9 9/64]

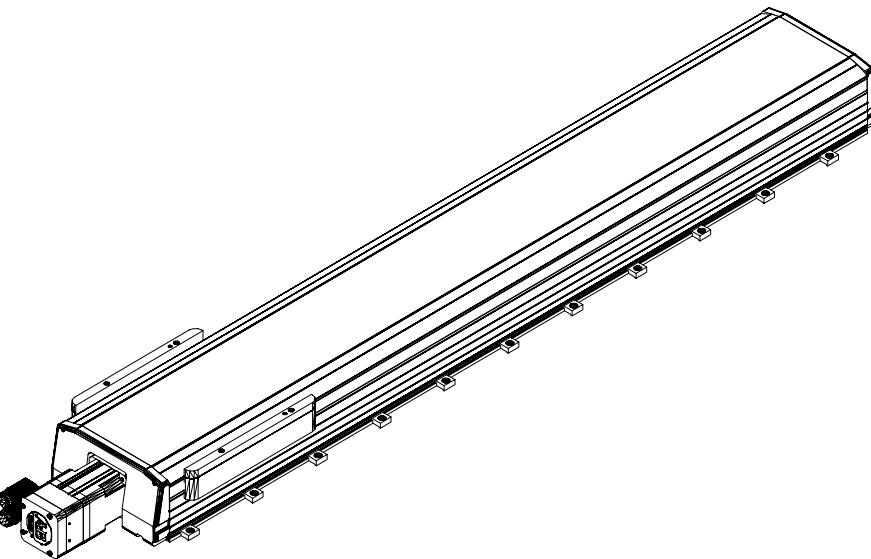

105.40 [4 5/32]



MPAS-A81022-V20S2A  
MP Linear Stage, Frame  
200, 230v, 1020mm  
Stroke Length,  
Multi-turn, 20mm Screw  
Lead, with Cover