

232.01 [9 9/64]

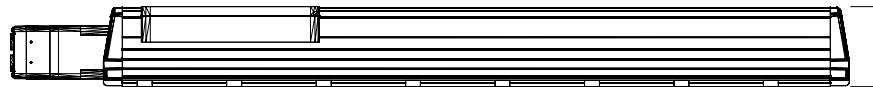

105.40 [4 5/32]

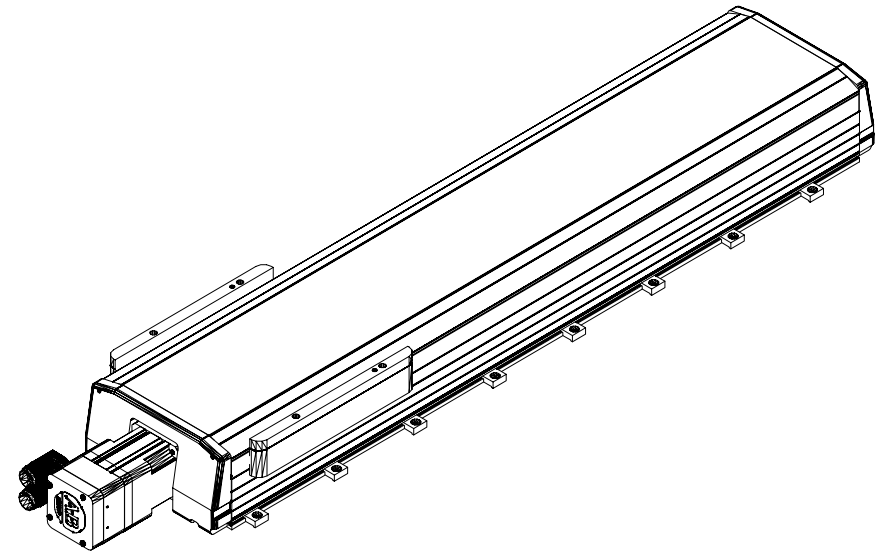

MPAS-A80662-V20S2A
MP Linear Stage, Frame
200, 230v, 660mm
Stroke Length,
Multi-turn, 20mm Screw
Lead, with Cover