

181.50 [7 9/64]

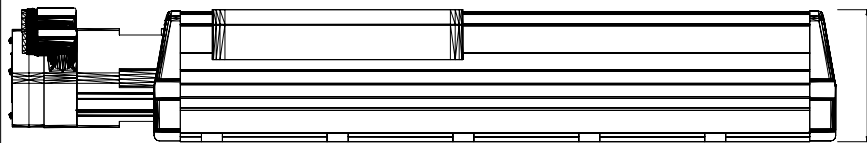

123.80 [4 7/8]

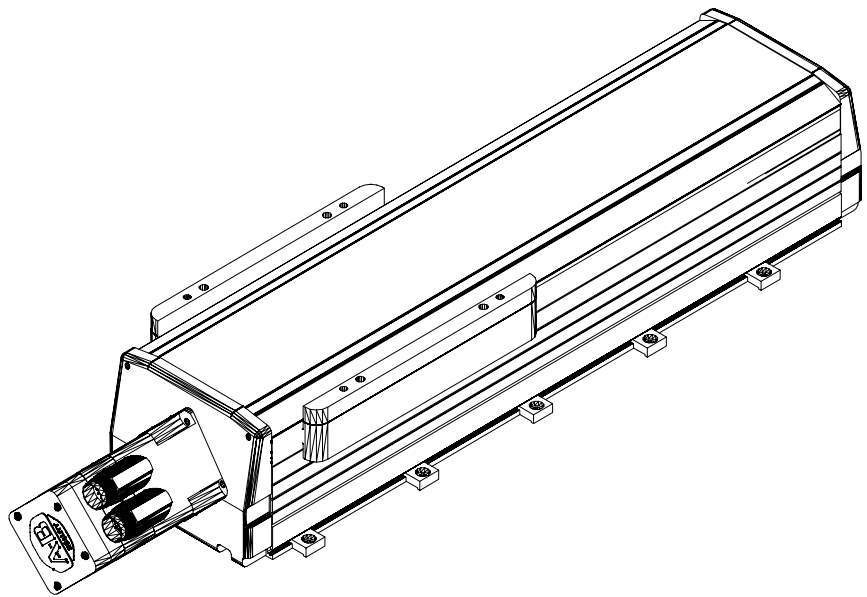

MPAS-B60301-V05S4A
MP Linear Stage, Frame
150, 460v, 300mm Stroke
Length, Multi-turn,
05mm Screw Lead, with
Cover and Brake