

181.50 [7 9/64]

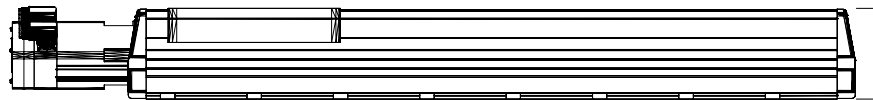

123.80 [4 7/8]

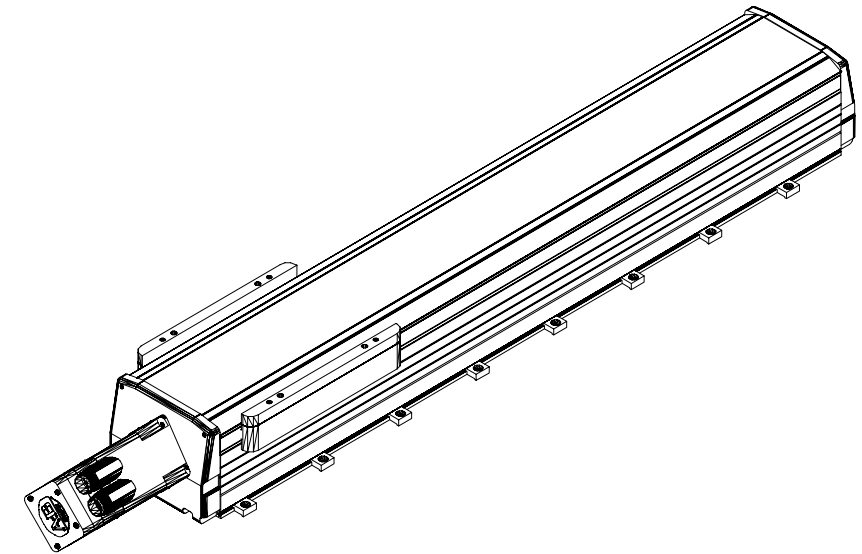

MPAS-B60662-V20S4A  
MP Linear Stage, Frame  
150, 460v, 660mm Stroke  
Length, Multi-turn,  
20mm Screw Lead, with  
Cover and Brake