

181.50 [7 9/64]

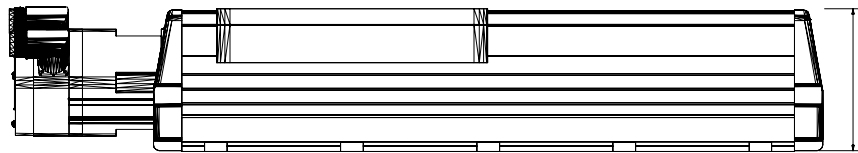

123.16 [4 27/32]

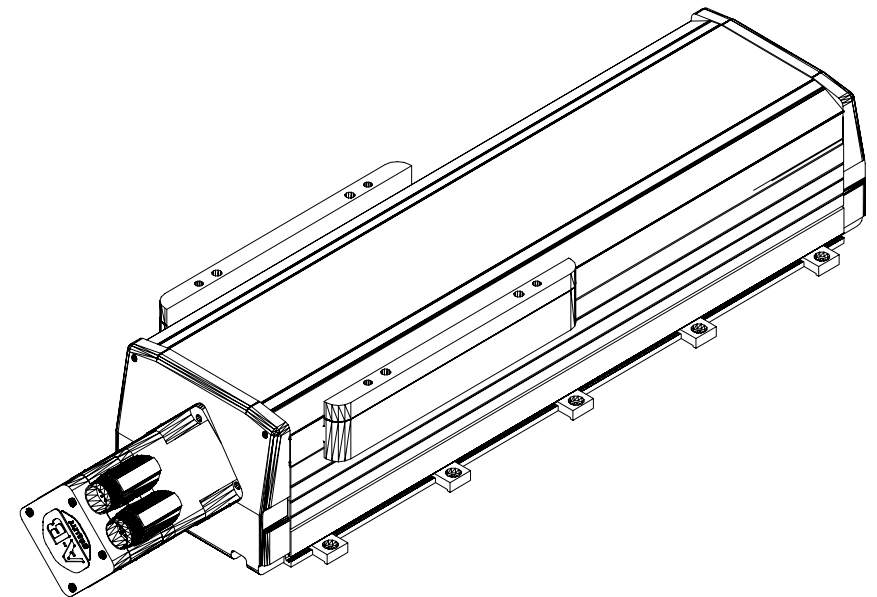

MPAS-B60242-V20S2A
MP Linear Stage, Frame
150, 460v, 240mm Stroke
Length, Multi-turn,
20mm Screw Lead, with
Cover