

181.05 [7 1/8]

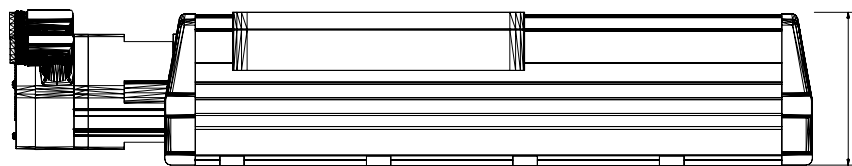

123.16 [4 27/32]

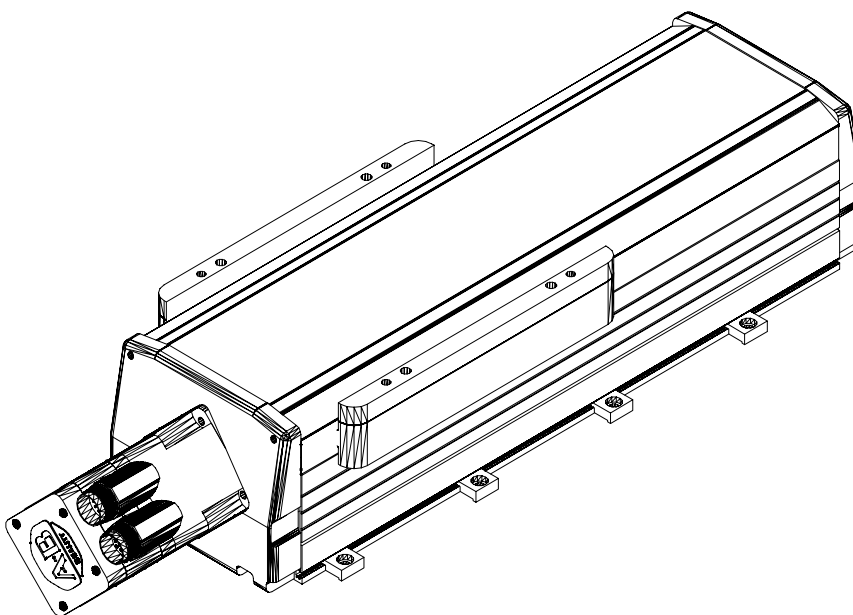

MPAS-B60182-V20S2A  
MP Linear Stage, Frame  
150, 460v, 180mm Stroke  
Length, Multi-turn,  
20mm Screw Lead, with  
Cover