

180.60 [7 7/64]

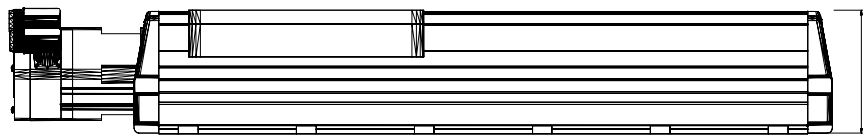

123.16 [4 27/32]

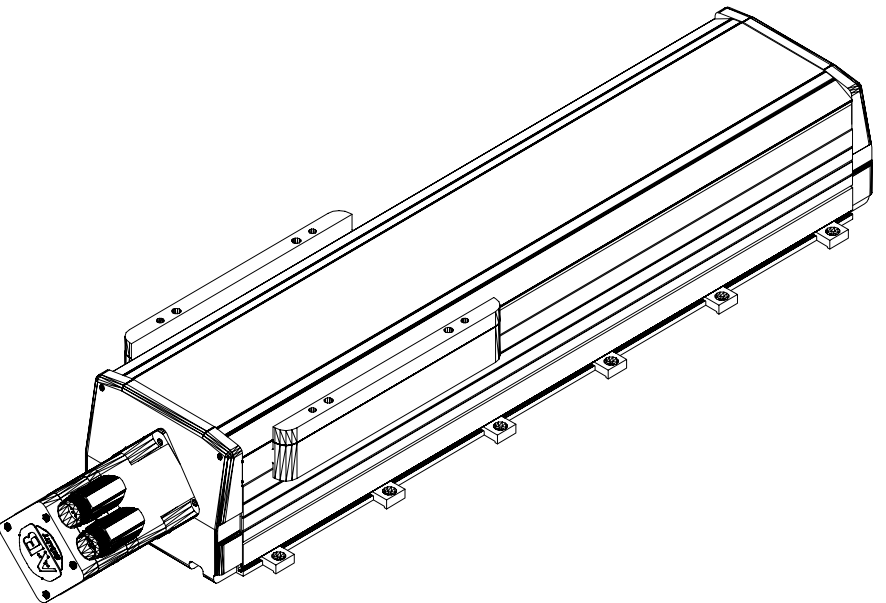

MPAS-A60362-V20S2A
MP Linear Stage, Frame
150, 230v, 360mm Stroke
Length, Multi-turn,
20mm Screw Lead, with
Cover