

181.50 [7 9/64]

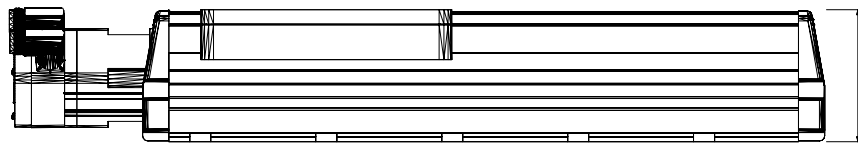

123.80 [4 7/8]

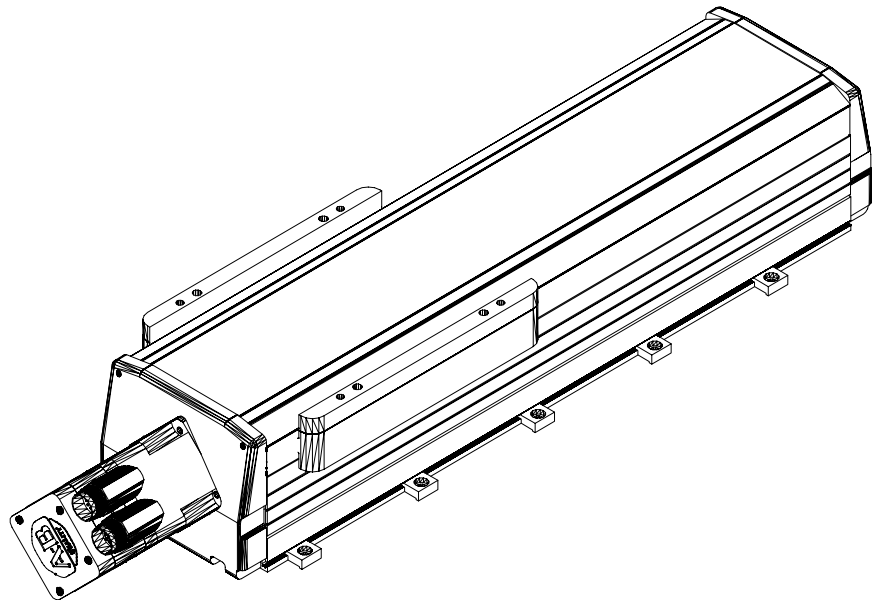

MPAS-A60302-V20S2A
MP Linear Stage, Frame
150, 230v, 300mm Stroke
Length, Multi-turn,
20mm Screw Lead, with
Cover