

12 5/16 [312.84]

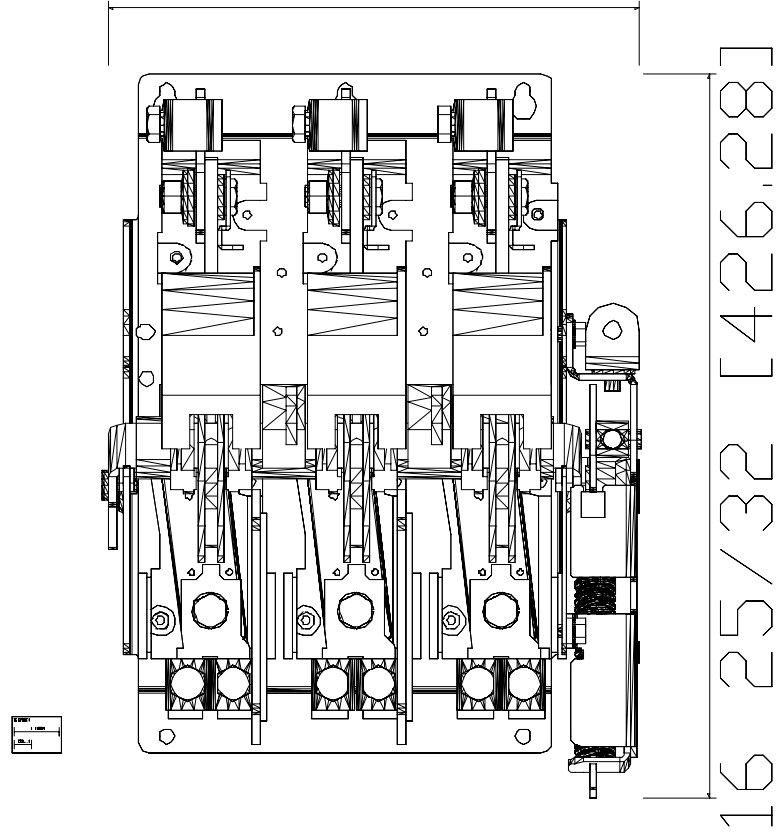

16 25/32 [426.28]