

12 1/16 [306.32]

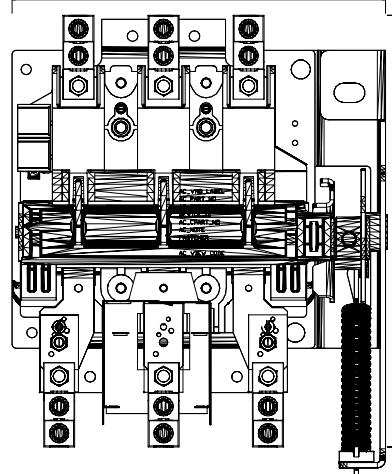

13 15/16 [354.00]

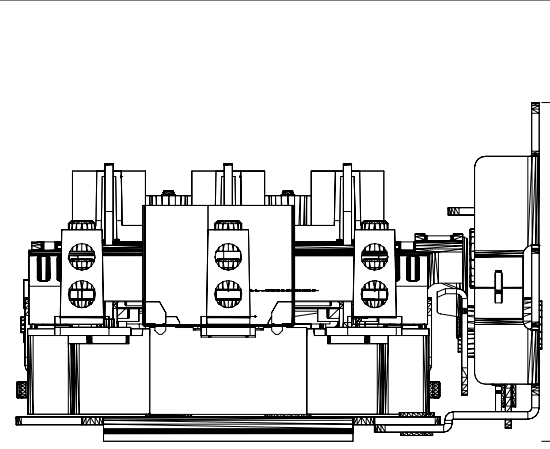

7 13/16 [198.30]

1494V-DS400
Disconnect Switch, 400A,
Right Side (SERIES D)

