

PowerFlex 700 Adjustable Frequency AC Drive



| Topic | Page |
|---|------|
| Product Overview | 2 |
| Certifications and Specifications | 7 |
| Design Considerations | 12 |
| Drive, Fuse and Circuit Breaker Ratings | 24 |
| Cable Recommendations | 33 |
| Power Wiring | 34 |
| I/O Wiring | 44 |
| Mounting | 49 |
| Dimensions and Weights | 53 |
| PowerFlex 700 Packaged Drives | 77 |
| Drive Options | 78 |

LISTEN.
THINK.
SOLVE.®

Additional Resources

These documents contain additional information concerning related products from Rockwell Automation.

| Resource | Description |
|---|---|
| PowerFlex 700 Adjustable Frequency AC Drive Installation Instructions – Frames 0...6, publication 20B-IN0019 | Provides detailed information about installation and start-up. |
| PowerFlex 700 Adjustable Frequency AC Drive Installation Instructions – Frames 7...10, publication 20B-IN0014 | |
| PowerFlex 700 Standard Control User Manual, publication 20B-UM001 | Provides detailed information on: <ul style="list-style-type: none"> Parameters and programming Faults, alarms, and troubleshooting |
| PowerFlex 700 Vector Control User Manual (v4.001 & up), publication 20B-UM002 | |
| PowerFlex 70 and PowerFlex 700 Reference Manual, publication PFLEX-RM001 | These publications provide detailed application specific information for programming and configuring the PowerFlex 700 drive. |
| PowerFlex 70 Enhanced Control and PowerFlex 700 Vector Control Reference Manual, publication PFLEX-RM004 | |
| Wiring and Grounding Guidelines for Pulse Width Modulated (PWM) AC Drives, publication DRIVES-IN001 | Provides basic information needed to properly wire and ground PWM AC drives. |
| Safety Guidelines for the Application, Installation and Maintenance of Solid State Control, publication SGI-1.1 | Provides general guidelines for the application, installation, and maintenance of solid-state control. |
| Preventive Maintenance of Industrial Control and Drive System Equipment, publication DRIVES-TD001 | Provides a guide to performing preventive maintenance. |
| Guarding Against Electrostatic Damage, publication 8000-4.5.2 | Provides practices for guarding against Electrostatic damage (ESD) |
| Product Certifications website, http://ab.com | Provides declarations of conformity, certificates, and other certification details. |

You can view or download publications at <http://www.rockwellautomation.com/literature/>. To order paper copies of technical documentation, contact your local Allen-Bradley distributor or Rockwell Automation sales representative.

Product Overview

The PowerFlex 700 AC drive offers outstanding performance in an easy-to-use drive that you have come to expect from Rockwell Automation. This world-class performance comes in a small and competitively priced package. The PowerFlex 700 AC drive is designed to control three-phase induction motors in applications with requirements ranging from the simplest speed control to the most demanding torque control. The drive has volts per hertz, sensorless vector and vector control. Vector control includes Allen-Bradley's patented Force™ Technology which provides world class motor control.



Flexible Packaging and Mounting

- **IP20, NEMA/UL Type 1** – For conventional mounting inside or outside a control cabinet. Conduit plate is removable for easy installation and replacement without disturbing conduit.
- **IP54, NEMA/UL Type 12** – Stand-alone, wall mount drives are available for dust tight applications with power ratings from 75 to 200 Hp (Frames 5 & 6).
- **IP54, NEMA/UL Type 12** – Flange mount drives with an IP00, NEMA/UL Type Open front. These can be installed in a user supplied cabinet to meet IP54, NEMA/UL Type 12. This allows the majority of heat to be exhausted out the back of the cabinet while keeping the cabinet protected. Power ratings range from 75 to 700 Hp (Frames 5...10).
- **Zero Stacking™** – Frame 0...6 drives can be mounted next to each other with no reduction of surrounding air temperature rating (50°C). This unique bookshelf design also allows access to one drive without disturbing another.

Space Saving Hardware Features

- **Integral EMC Filtering** plus built-in DC bus choke common mode cores and common mode capacitors provides a compact, all-in-one package solution for meeting EMC requirements, including CE in Europe. Frames 0...6 only (Frames 7...10 meet CE when installed per recommendations).
- **Internal Communications** allow the user to integrate the drive into the manufacturing process. Status indicators for all internal communication options are visible on the cover for easy setup and monitoring of drive communications. Users can easily manage information from shop floor to top floor and seamlessly integrate their complete system as they control, configure and collect data.
- **Integral Dynamic Brake Transistor** delivers a cost effective means of switching regenerative energy without costly external chopper circuits. These internal transistors are available in power ratings from 0.5 to 200 Hp.
- **Internal Dynamic Brake Resistor** (up to 25 Hp) requires no extra panel space, and supplies a large amount of braking torque for short periods.

Easy to Use Human Interface Tools

The PowerFlex 7-Class AC drives provide common Human Interface tools that are familiar and easy to use. These include the LCD Human Interface modules and PC-based configuration tools.

- LCD Human Interface modules provide:
 - Large and easy to read 7 line x 21 character backlit display
 - Variety of languages (English, French, German, Italian, Spanish, Portuguese, Dutch)
 - Alternate function keys for shortcuts to common tasks
 - “Calculator-like” number pad for fast and easy data entry (Full Numeric version only)
 - Control keys for local start, stop, speed, and direction
 - Remote versions for panel mount application

Outstanding Control and Performance

Multiple motor control algorithms allow performance matched to the application need:

- **Volts/Hertz** for simple Fan and Pump applications.
- **Sensorless Vector** for high torque production over a wide speed range.
- **Vector** for outstanding torque regulation and excellent low speed/zero speed performance (w/Vector Control cassette).

The PowerFlex 700 drive's Vector Control uses Allen-Bradley's patented Force™ Technology which provides excellent low-speed performance - whether it is operated with or without feedback. While this industry-leading control provides the highest level of drive performance, it is as easy to use as any general purpose drive available.

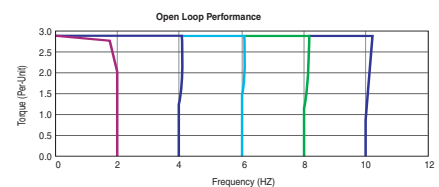
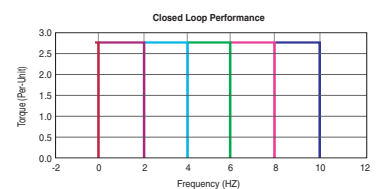

Drives Features

- Fast-acting **Current Limit** and **Bus Voltage Regulation** result in maximum accel/decel without tripping.
- **High speed analog inputs** improve drive response to torque or speed commands.
- **Programming flexibility** allows parameters to be linked within the drive.
- **Flying Start** delivers smooth and instantaneous connection into rotating loads, regardless of commanded direction, without the need for any speed feedback.
- **Integral Process PI Control** can eliminate the need for a separate process loop controller.
- **Inertia Ride-Through** offers tripless operation during a prolonged power outage by using the rotating energy stored in high inertia, low-friction loads.
- **Position Indexer/Speed Profiler** uses a 16 step indexer to provide point-to-point positioning or velocity profiling based on encoder counts, digital inputs, parameter levels or time.
- **TorqProve™** assures control of the load when transferring control between the drive and a mechanical brake.
- **Speed Regulation** - Open Loop or Closed Loop
 - **Slip Compensation** delivers a minimum 0.5% speed regulation without feedback hardware.
 - **Droop** allows drives to load share without fighting each other.
 - **Encoder Feedback** provides up to 0.001% speed regulation for the tightest application requirements.
- **Torque Regulation** - Open Loop or Closed Loop
 - **Open Loop** torque regulation provides $\pm 5\%$ regulation.
 - **Encoder Feedback** provides $\pm 2\%$ regulation and the ability to hold full load at zero speed.

Unsurpassed Capability in Network Communications

PowerFlex drives are fully compatible with the wide variety of Allen-Bradley DPI™ communication adapters, offering the following benefits:

| BAcnet® | ControlNet™ | DeviceNet™ | EtherNet/IP™ | LonWorks™ | Modbus RTU | PROFIBUS™ | Remote I/O (1) | RS485 DFI | USB | Description |
|---------|-------------|------------|--------------|-----------|------------|-----------|----------------|-----------|-----|---|
| | ✓ | ✓ | ✓ | | | | | | | (Unconnected Messaging) permits other network devices (e.g. PanelView™) to communicate directly to a drive without routing the communication through the network scanner. |
| ✓ | ✓ | ✓ | ✓ | | | | | ✓ | ✓ | Adapter Routing - Plug PC into one drive and talk to all other Allen-Bradley drives on same network, without being routed through network scanner. |
| ✓ | ✓ | ✓ | ✓ | ✓ | ✓ | ✓ | ✓ | ✓ | ✓ | Access to 100% of all parameters over the network. |
| ✓ | | ✓ | ✓ | | | ✓ | | | | AutoBaud capability makes initial connections less problematic. |
| | | ✓ | | | | | | | | Change of State significantly reduces network traffic by configuring control messages to be sent only upon customer defined states. Very flexible configuration for each node (Example: "reference must change by more than 5%"). |
| | | ✓ | ✓ | | | | | | | Peer Control provides master-slave type control between drives, where one or more slave drives (consumers) can run based on the status of a master drive (producer), which can also significantly reduce network traffic. |
| | | ✓ | | | | | | | | ADR (Automatic Device Replacement) saves significant time and effort when replacing a drive, by allowing the scanner to be configured to automatically detect a new drive and download the required parameter settings. |
| ✓ | ✓ | ✓ | ✓ | ✓ | ✓ | ✓ | ✓ | ✓ | ✓ | Flexible Fault Configuration - Adapters can be programmed to take fault based actions as ramp to stop, coast-to-stop and hold last state, as well as send user configurable logic control and speed reference values. In addition, different actions can be taken based on whether the network experienced a serious problem (broken cable etc.) versus network idle condition (PLC set to "Program"). |

(1) This item has Silver Series status. For information, refer to <http://www.ab.com/silver>.

Catalog Number Explanation

20B **D** **2P1** **A** **3** **A** **Y** **N** **A** **E** **C** **O** **NN** **AD**
a *b* *c1...c5* *d* *e* *f* *g* *h* *i* *j* *k* *l* *m* *n*

a

| Drive | |
|-------|---------------|
| Code | Type |
| 20B | PowerFlex 700 |

b

| Voltage Rating | | | | |
|----------------|---------|-----|---------|-----------|
| Code | Voltage | Ph. | Prechg. | Frames |
| B | 240V AC | 3 | - | 0...6 |
| C | 400V AC | 3 | - | 0...10 |
| D | 480V AC | 3 | - | 0...10 |
| E | 600V AC | 3 | - | 0...6 |
| F | 690V AC | 3 | - | 5...6 |
| H | 540V DC | - | N | 5...6, 10 |
| J | 650V DC | - | N | 5...6, 10 |
| N | 325V DC | - | Y | 5...6 |
| P | 540V DC | - | Y | 5...9 |
| R | 650V DC | - | Y | 5...9 |
| T | 810V DC | - | Y | 5...6 |
| W | 932V DC | - | Y | 5...6 |

c1

| ND Rating | | | | |
|-----------------------|-----------|-----------|-----|-------|
| 208/240V, 60 Hz Input | | | | |
| Code | 208V Amps | 240V Amps | Hp | Frame |
| 2P2 | 2.5 | 2.2 | 0.5 | 0 |
| 4P2 | 4.8 | 4.2 | 1.0 | 0 |
| 6P8 | 7.8 | 6.8 | 2.0 | 1 |
| 9P6 | 11 | 9.6 | 3.0 | 1 |
| 015 | 17.5 | 15.3 | 5.0 | 1 |
| 022 | 25.3 | 22 | 7.5 | 1 |
| 028 | 32.2 | 28 | 10 | 2 |
| 042 | 48.3 | 42 | 15 | 3 |
| 052 | 56 | 52 | 20 | 3 |
| 070 | 78.2 | 70 | 25 | 4 |
| 080 | 92 | 80 | 30 | 4 |
| 104 | 120 | 104 | 40 | 5 |
| 130 | 130 | 130 | 50 | 5 |
| 154 | 177 | 154 | 60 | 6 |
| 192 | 221 | 192 | 75 | 6 |
| 260 | 260 | 260 | 100 | 6 |

c2

| ND Rating | | | |
|-------------------|------|------|-------|
| 400V, 50 Hz Input | | | |
| Code | Amps | kW | Frame |
| 1P3 | 1.3 | 0.37 | 0 |
| 2P1 | 2.1 | 0.75 | 0 |
| 3P5 | 3.5 | 1.5 | 0 |
| 5P0 | 5.0 | 2.2 | 0 |
| 8P7 | 8.7 | 4.0 | 0 |
| 011 | 11.5 | 5.5 | 0 |
| 015 | 15.4 | 7.5 | 1 |
| 022 | 22 | 11 | 1 |
| 030 | 30 | 15 | 2 |
| 037 | 37 | 18.5 | 2 |
| 043 | 43 | 22 | 3 |
| 056 | 56 | 30 | 3 |
| 072 | 72 | 37 | 3 |
| 085 | 85 | 45 | 4 |
| 105 | 105 | 55 | 5 |
| 125 | 125 | 55 | 5 |
| 140 | 140 | 75 | 5 |
| 170 | 170 | 90 | 6 |
| 205 | 205 | 110 | 6 |
| 260 | 260 | 132 | 6 |
| 292 | 292 | 160 | 7 |
| 325 | 325 | 180 | 7 |
| 365 | 365 | 200 | 8 |
| 415 | 415 | 240 | 8 |
| 481 | 481 | 280 | 8 |
| 535 | 535 | 300 | 8 |
| 600 | 600 | 350 | 8 |
| 730 | 730 | 400 | 9 |
| 875 | 875 | 500 | 10 |

c3

| ND Rating | | | |
|-------------------|------|-----|-------|
| 480V, 60 Hz Input | | | |
| Code | Amps | Hp | Frame |
| 1P1 | 1.1 | 0.5 | 0 |
| 2P1 | 2.1 | 1.0 | 0 |
| 3P4 | 3.4 | 2.0 | 0 |
| 5P0 | 5.0 | 3.0 | 0 |
| 8P0 | 8.0 | 5.0 | 0 |
| 011 | 11 | 7.5 | 0 |
| 014 | 14 | 10 | 1 |
| 022 | 22 | 15 | 1 |
| 027 | 27 | 20 | 2 |
| 034 | 34 | 25 | 2 |
| 040 | 40 | 30 | 3 |
| 052 | 52 | 40 | 3 |
| 065 | 65 | 50 | 3 |
| 077 | 77 | 60 | 4 |
| 096 | 96 | 75 | 5 |
| 125 | 125 | 100 | 5 |
| 156 | 156 | 125 | 6 |
| 180 | 180 | 150 | 6 |
| 248 | 248 | 200 | 6 |
| 292 | 292 | 250 | 7 |
| 325 | 325 | 250 | 7 |
| 365 | 365 | 300 | 8 |
| 415 | 415 | 350 | 8 |
| 481 | 481 | 400 | 8 |
| 535 | 535 | 450 | 8 |
| 600 | 600 | 500 | 8 |
| 730 | 730 | 600 | 9 |
| 875 | 875 | 700 | 10 |

c4

| ND Rating | | | |
|-------------------|------|-----|-------|
| 600V, 60 Hz Input | | | |
| Code | Amps | Hp | Frame |
| 1P7 | 1.7 | 1.0 | 0 |
| 2P7 | 2.7 | 2.0 | 0 |
| 3P9 | 3.9 | 3.0 | 0 |
| 6P1 | 6.1 | 5.0 | 0 |
| 9P0 | 9.0 | 7.5 | 0 |
| 011 | 11 | 10 | 1 |
| 017 | 17 | 15 | 1 |
| 022 | 22 | 20 | 2 |
| 027 | 27 | 25 | 2 |
| 032 | 32 | 30 | 3 |
| 041 | 41 | 40 | 3 |
| 052 | 52 | 50 | 3 |
| 062 | 62 | 60 | 4 |
| 077 | 77 | 75 | 5 |
| 099 | 99 | 100 | 5 |
| 125 | 125 | 125 | 6 |
| 144 | 144 | 150 | 6 |

20B **D** **2P1** **A** **3** **A** **Y** **N** **A** **E** **C** **0** **NN** **AD**
a *b* *c1...c5* *d* *e* *f* *g* *h* *i* *j* *k* *l* *m* *n*

c5

| ND Rating | | | |
|-------------------|------|-----|-------|
| 690V, 50 Hz Input | | | |
| Code | Amps | KW | Frame |
| 052 | 52 | 45 | 5 |
| 060 | 60 | 55 | 5 |
| 082 | 82 | 75 | 5 |
| 098 | 98 | 90 | 6 |
| 119 | 119 | 110 | 6 |
| 142 | 142 | 132 | 6 |

d

| Enclosure | |
|-----------|--|
| Code | Enclosure |
| A | IP20, NEMA/UL Type 1 |
| F ♣ | Open/Flange Mount Front: IP00, NEMA/UL Type Open Back/Heatsink: IP54, NEMA Type 12 |
| N ♣ | Open/Flange Mount Front: IP00, NEMA/UL Type Open Back/Heatsink: IP54, NEMA 12 |
| G ♣ | Stand-Alone/Wall Mount IP54, NEMA/UL Type 12 |
| U | Roll-In Front: IP00, NEMA/UL Type Open Back/Heatsink: IP54, NEMA 12 Frames 8 & 9 Only |

♣ Only available for Frame 5 & Frame 6 drives, 400...690V.
 ♣ Only available for Frames 7...10.

e

| HIM | |
|------|--|
| Code | Operator Interface |
| 0 | Blank Cover |
| 3 | LCD Display, Full Numeric Keypad |
| J ♣ | Remote (Panel Mount), IP66, NEMA/UL Type 12 Full Numeric LCD HIM |
| K ♣ | Remote (Panel Mount), IP66, NEMA/UL Type 12 Prog. Only LCD HIM |

♣ Available with Frames 5...6 Stand-Alone IP54 drives (Enclosure Code "G").

f

| Documentation | |
|---------------|---|
| Code | Type |
| A | Manual |
| N | No Manual |
| Q | No Shipping Package (Internal Use Only) |

g

| Brake | |
|-------|----------------|
| Code | w/Brake IGBT ‡ |
| Y | Yes |
| N | No |

‡ Brake IGBT is standard on Frames 0-3, optional on Frames 4-6 and not available on Frames 7...10.

h

| Internal Braking Resistor | |
|---------------------------|------------|
| Code | w/Resistor |
| Y | Yes ★ |
| N | No |

★ Not available for Frame 3 drives or larger.

i

| Emission | | |
|----------|-------------|----------|
| Code | CE Filter § | CM Choke |
| A | Yes | Yes |
| B # | Yes | No |
| N | No | No |

§ Note: 600V class drives below 77 Amps (Frames 0-4) are declared to meet the Low Voltage Directive. It is the responsibility of the user to determine compliance to the EMC directive. Frames 7...10, 400/480V AC drives (Voltage Rating codes "C" and "D") meet CE certification requirements when installed per recommendations.

Only available for 208...240V Frame 0-3 drives.

j

| Comm Slot | |
|-----------|-------------------|
| Code | Network Type |
| C | ControlNet (Coax) |
| D | DeviceNet |
| E | EtherNet/IP |
| N | None |

k

| Control & I/O | | |
|---------------|------------|-----------|
| Code | Control | I/O Volts |
| A | Standard ♣ | 24V DC/AC |
| B | Standard ♣ | 115V AC |
| C | Vector Δ | 24V DC |
| D | Vector Δ | 115V AC |
| N | Standard | None |

Δ Vector Control Option utilizes DPI Only.

♣ Frame 0...6 drives only.

l

| Feedback | |
|----------|-----------------|
| Code | Type |
| 0 | None |
| 1 | Encoder, 12V/5V |

m

Future Use

n

| Special Firmware (Frames 0...6 Only) | |
|--------------------------------------|----------------------------|
| Code | Type |
| AD ♣ | 60 Hz Maximum |
| AE ♣ | Cascading Fan/Pump Control |
| AX ♣ | 82 Hz Maximum |
| BA ♣ | Pump Off (for pump jack) |

♣ Must be used with Vector Control option C or D (Position k). Positions m-n are only required when custom firmware is supplied.

Certifications and Specifications

Certifications

| Certification ⁽¹⁾ | Description | Frames | | | |
|---|---|------------|------|-------|------------------|
| | | 0...4 | | 5...6 | 7...10 |
| | | 230...480V | 600V | | |
| ABS | American Bureau of Shipping MA Certificate 08-HS303172B/1-PDA for auxiliary services on AB Classed vessels and offshore platforms | ✓ | | ✓ | |
| CE | Certified by Rockwell Automation to be in conformity with the essential requirements of the applicable European Directives and the standards referenced below have been applied: | | | | |
| | 2006/95/EC (Low Voltage Directive) EN 50178 Electronic Equipment for use in Power Installations | ✓ | ✓ | ✓ | ✓ |
| | 2004/108/EC (EMC Directive) EN 61800-3 Adjustable Speed electrical power drive systems - Part 3: EMC requirements and specific test methods. | ✓ | | ✓ | ✓ ⁽²⁾ |
| C-Tick | Certified by Rockwell Automation to be in conformity with the requirements of the applicable Australian legislation and the standards referenced: IEC 61800-3. | ✓ | | ✓ | ✓ |
| c-UL-us | Listed to UL508C and C22.2 No. 14. Packaged drives may be listed to UL508A. | ✓ | ✓ | ✓ | ✓ |
| EPRI /SEMIF47 | EPRI Quality Star Certificates SEMIF47.115 and SEMIF47.127 for SEMI F47 compliance, 480V units tested | ✓ | | ✓ | |
| Korean KC Registration | KCC-REM-RAA-20B Refer to the certificate of registration for specific drive catalog numbers that have this certification. | ✓ | ✓ | ✓ | ✓ |
| Lloyd's Register | Lloyd's Register Type Approval Certificate 08 / 60015 (marine certification) | ✓ | | ✓ | |
| RINA | RINA Type Approval Certificate ELE283205CS (Registo Italiano Navale - marine certification) | ✓ | ✓ | ✓ | |
| Trentec | Tested by Trentec to be compliant with AC156 Acceptance Criteria for Seismic Qualification Testing of Nonstructural Components and 2003 International Building Code for worst-case seismic level for USA excluding site class F | ✓ | ✓ | ✓ | |
| TÜV ATEX | EC-Type-Examination Certificate TUV 05 ATEX 7153 for directive 94/9/EC: Safe turn off of certified ATEX motors used in Group II Category (2) GD potentially explosive atmospheres. | ✓ | ✓ | ✓ | ✓ |
| Designed to Meet Applicable Requirements | CMAA Specification #70 (Crane Manufacturers of America Assoc.) | ✓ | ✓ | ✓ | ✓ |
| | NFPA 70 - US National Electrical Code | ✓ | ✓ | ✓ | ✓ |
| | NEMA ICS 7.1 - Safety Standards for Construction and Guide for Selection, Installation, and Operation of Adjustable Speed Drive Systems | ✓ | ✓ | ✓ | ✓ |
| | IEC 61800-2 Adjustable Speed Electrical Power Drive Systems - Part 2: General Requirements - Rating specifications for low voltage adjustable frequency AC power drive systems. | ✓ | ✓ | ✓ | ✓ |

(1) See the product certifications website, <http://www.rockwellautomation.com/products/certification> for declarations of conformity, certificates, and other certification details.

(2) Frames 7...10 provided as IP00 or NEMA/UL Open style must be installed in a supplementary enclosure which provides adequate attenuation of radiated emissions in order to be compliant with EN 61800-3.

Environmental

| Category | Specification | | | | |
|-------------|---|---|--------------|-------------|---|
| Environment | Altitude: | 1000 m (3300 ft) max. without derating | | | |
| | Maximum Surrounding Air Temperature without Derating - IP20, NEMA/UL Type Open: Frames 0...6 Frames 7...10 | 0...50 °C (32...122 °F), typical. See Installation Instructions for details. 0...40 °C (32...104 °F) for chassis (heatsink) 0...65 °C (32...149 °F) for control (front of backplane) | | | |
| | Storage Temperature (all const.): | -40...70 °C (-40...158 °F) | | | |
| | Atmosphere: | Important: Drive must not be installed in an area where the ambient atmosphere contains volatile or corrosive gas, vapors or dust. If the drive is not going to be installed for a period of time, it must be stored in an area where it will not be exposed to a corrosive atmosphere. | | | |
| | Relative Humidity: | 5 to 95% non-condensing | | | |
| | Shock: | 15G peak for 11ms duration (±1.0 ms) | | | |
| | Vibration: | 0.152 mm (0.006 in.) displacement, 1G peak | | | |
| | Surrounding Environment Pollution Degree Pollution Degree 1 & 2: Pollution Degree 3 & 4: (See page 11 for descriptions of each pollution degree rating.) | All enclosures acceptable. Enclosure that meets or exceeds IP54, NEMA/UL Type 12 required. | | | |
| | Sound: | Frame | Fan Velocity | Sound Level | Note: Sound pressure level is measured at 2 meters. |
| | | 0 | 30 CFM | 58 dB | |
| | | 1 | 30 CFM | 59 dB | |
| | | 2 | 50 CFM | 57 dB | |
| | | 3 | 120 CFM | 61 dB | |
| 4 | | 190 CFM | 59 dB | | |
| 5 | | 200 CFM | 71 dB | | |
| 6 | | 300 CFM | 72 dB | | |
| 7 | | 756 CFM | 74 dB | | |
| 8 | | 1200 CFM | 78 dB | | |
| 9 | | 2800 CFM | 82 dB | | |
| 10 Inv. | | 1850 CFM | 78 dB | | |
| 10 Cnv. | 1200 CFM | 78 dB | | | |

Technical Specifications

| Category | Specification | | | | | | | |
|-------------------------------|--|--|---------|----------|---------|----------------------|--------------------------|--|
| Protection | Drive | 200...208V | 240V | 380/400V | 480V | 600V Frames 0...4 | 600/690V Frames 5...6 | |
| | AC Input Overvoltage Trip: | 285V AC | 285V AC | 570V AC | 570V AC | 716V AC | 818V AC | |
| | AC Input Undervoltage Trip: | 120V AC | 138V AC | 233V AC | 280V AC | 345V AC | 345V AC | |
| | Bus Overvoltage Trip: | 405V DC | 405V DC | 810V DC | 810V DC | 1013V DC | 1162V DC | |
| | Bus Undervoltage Shutoff/Fault: | 153V DC | 153V DC | 305V DC | 305V DC | 381V DC | 437V DC | |
| | Nominal Bus Voltage: | 281V DC | 324V DC | 540V DC | 648V DC | 810V DC | 932V DC | |
| | All Drives | | | | | | | |
| | Heat Sink Thermistor: | Monitored by microprocessor overtemp trip | | | | | | |
| | Drive Overcurrent Trip | 200% of rated current (typical) | | | | | | |
| | Software Overcurrent Trip: | 220...300% of rated current (dependent on drive rating) | | | | | | |
| Hardware Overcurrent Trip: | | | | | | | | |
| Line transients: | up to 6000 volts peak per IEEE C62.41-1991 | | | | | | | |
| Control Logic Noise Immunity: | Showering arc transients up to 1500V peak | | | | | | | |
| Power Ride-Thru: | 15 milliseconds at full load | | | | | | | |
| Logic Control Ride-Thru: | 0.5 seconds minimum, 2 seconds typical | | | | | | | |
| Ground Fault Trip: | Phase-to-ground on drive output | | | | | | | |
| Short Circuit Trip: | Phase-to-phase on drive output | | | | | | | |
| Electrical | Voltage Tolerance: | See page 12 for full power and operating range | | | | | | |
| | Input Frequency Tolerance: | 47...63 Hz | | | | | | |
| | Input Phases: | Three-phase input provides full rating for all drives. Single-phase operation possible on certain drives and provides 50% of rated current (see Installation Instructions for details). Frames 0...7: Drive can be supplied as 6 pulse or 18 pulse in an engineered package. | | | | | | |
| | Displacement Power Factor: | 0.98 across entire speed range | | | | | | |
| | Efficiency: | 97.5% at rated amps, nominal line volts | | | | | | |
| | Maximum Short Circuit Rating: | 200,000 Amps symmetrical | | | | | | |
| | Actual Short Circuit Rating: | Determined by AIC rating of installed fuse/circuit breaker | | | | | | |
| | Drive to Motor Power Ratio | | | | | | | |
| Minimum | Recommended not less than 1:2 ratio | | | | | | | |
| Maximum | Recommended not greater than 2:1 ratio | | | | | | | |

| Category | Specification | |
|---|--|--|
| Control | Method: | Sine coded PWM with programmable carrier frequency. Ratings apply to all drives (refer to the <i>Derating Guidelines</i> in the PowerFlex Reference Manual). The drive can be supplied as 6 pulse or 18 pulse in a configured package. |
| | Carrier Frequency: | 2, 4, 8, and 10 kHz. Drive rating based on 4 kHz. See the Input Protection Device tables in the Installation Instructions for exceptions. |
| | Output Voltage Range: | 0 to rated motor voltage |
| | Output Frequency Range: | Standard Control – 0 to 400 Hz., Vector Control – 0 to 420 Hz |
| | Frequency Accuracy Digital Input: Analog Input: | Within $\pm 0.01\%$ of set output frequency Within $\pm 0.4\%$ of maximum output frequency |
| | Frequency Control: | Speed Regulation - w/Slip Compensation (Volts per Hertz Mode) 0.5% of base speed across 40:1 speed range, 40:1 operating range 10 rad/sec bandwidth |
| | | Speed Regulation - w/Slip Compensation (Sensorless Vector Mode) 0.5% of base speed across 80:1 speed range, 80:1 operating range 20 rad/sec bandwidth |
| | | Speed Regulation - w/Feedback (Sensorless Vector Mode) 0.1% of base speed across 80:1 speed range, 80:1 operating range 20 rad/sec bandwidth |
| | Speed Control: | Speed Regulation - w/o Feedback (Vector Control Mode) 0.1% of base speed across 120:1 speed range, 120:1 operating range 50 rad/sec bandwidth |
| | | Speed Regulation - w/Feedback (Vector Control Mode) 0.001% of base speed across 120:1 speed range, 1000:1 operating range, 250 rad/sec bandwidth |
| | Torque Regulation: | Torque Regulation - w/o Feedback $\pm 5\%$, 600 rad/sec bandwidth |
| | | Torque Regulation - w/Feedback $\pm 2\%$, 2500 rad/sec bandwidth |
| | Selectable Motor Control: | Sensorless Vector with full tuning. Standard V/Hz with full custom capability. PF700 adds Vector Control. |
| | Stop Modes: | Multiple programmable stop modes including - Ramp, Coast, DC-Brake, Ramp-to-Hold and S-curve. |
| | Accel/Decel: | Two independently programmable accel and decel times. Each time may be programmed from 0...3600 seconds in 0.1 second increments. |
| | Intermittent Overload: | 110% Overload capability for up to 1 minute, 150% Overload capability for up to 3 seconds. |
| Current Limit Capability: | Proactive Current Limit programmable from 20...160% of rated output current. Independently programmable proportional & integral gain. | |
| Motor Overload Protection Frames 0...6 Standard Control: | PowerFlex 700 drives with standard control, identified by an N, A, or B in position 15 of the catalog number, only provide Class 10 motor overload protection according to NEC article 430. They do not provide speed sensitive overload protection, thermal memory retention and motor over-temperature sensing according to NEC article 430.126 (A) (2). If such protection is needed in the end-use product, it must be provided by additional means. | |
| Frames 0...6 Vector Control: | PowerFlex 700 drives with vector control, identified by a C or D in position 15 of the catalog number, provide class 10 motor overload protection according to NEC article 430 and motor over-temperature protection according to NEC article 430.126 (A) (2). UL 508C File E59272. | |
| Frames 7...10 Vector Control: | Class 10 motor overload protection according to NEC article 430 and motor over-temperature protection according to NEC article 430.126 (A)(2). UL 508C File E59272. | |

| Category | Specification | | | | | | |
|------------------------|------------------------------|---|---------------------|---------------|-------------|---------|-------------|
| Control (continued) | Digital/Analog Input Latency | Signal | | Motor Control | Latency | | |
| | | | | | Min. | Max | Typical |
| | | Digital Input | Start | FVC | 8.4 ms | 10.4 ms | 8.4 ms |
| | | | | SVC | 9.2 ms | 16.0 ms | 9.2 ms |
| | | | Stop | FVC | 10.0 ms | 12.4 ms | 10.4 ms |
| | | | | SVC | 10.0 ms | 12.0 ms | 10.4 ms |
| | | Analog Input | Torque 4 kHz PWM | FVC | 772 μ s | 1.06 ms | 840 μ s |
| | | | Torque 2 kHz PWM | FVC | 1.008 ms | 1.46 ms | 1.256 ms |
| | | | Speed | FVC | 4.6 ms | 8.6 ms | 4.8 ms |
| | | | Speed | SVC | 4.8 ms | 12.4 ms | 6.4 ms |
| Encoder | Type: | Incremental, dual channel | | | | | |
| | Supply: | 12V, 250 mA. 12V, 10 mA minimum inputs isolated with differential transmitter, 250 kHz maximum. | | | | | |
| | Quadrature: | 90°, \pm 27 degrees at 25 degrees C. | | | | | |
| | Duty Cycle: | 50%, +10% | | | | | |
| | Requirements: | Encoders must be line driver type, quadrature (dual channel) or pulse (single channel), 8...15V DC output (4...6V DC when jumpers are in 5V position), single-ended or differential and capable of supplying a minimum of 10 mA per channel. Maximum input frequency is 250 kHz. The Encoder Interface Board accepts 12V DC square-wave with a minimum high state voltage of 7.0V DC. With the jumpers in the 5V position, the encoder will accept a 5V DC square-wave with a minimum high state voltage of 3.0V DC. In either jumper position, the maximum low state voltage is 0.4V DC. | | | | | |

Pollution Degree Ratings According to EN 61800-5-1

| Pollution Degree | Description |
|------------------|---|
| 1 | No pollution or only dry, non-conductive pollution occurs. The pollution has no influence. |
| 2 | Normally, only non-conductive pollution occurs. Occasionally, however, a temporary conductivity caused by condensation is to be expected, when the drive is out of operation. |
| 3 | Conductive pollution or dry non-conductive pollution occurs, which becomes conductive due to condensation, which is to be expected. |
| 4 | The pollution generates persistent conductivity caused, for example, by conductive dust, rain or snow. |

Design Considerations

Input Voltage Tolerance

| Drive Rating | Nominal Line Voltage | Nominal Motor Voltage | Drive Full Power Range | Drive Operating Range |
|----------------------------------|----------------------|-----------------------|------------------------|-----------------------|
| 200...240 | 200 | 200* | 200...264 | 180...264 |
| | 208 | 208 | 208...264 | |
| | 240 | 230 | 230...264 | |
| 380...480 | 380 | 380* | 380...528 | 342...528 |
| | 400 | 400 | 400...528 | |
| | 480 | 460 | 460...528 | |
| 500...600 (Frames 0...4 Only) | 600 | 575* | 575...660 | 432...660 |
| 500...690 (Frames 5 & 6 Only) | 600 | 575* | 575...660 | 475...759 |
| | 690 | 690 | 690...759 | 475...759 |

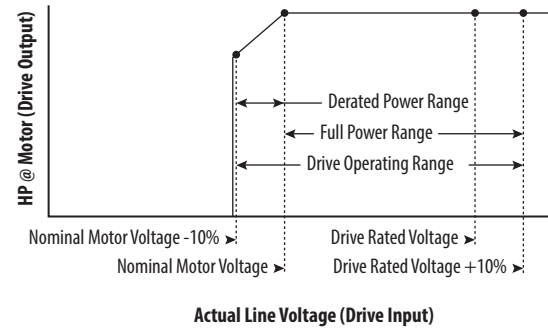

Drive Full Power Range = Nominal Motor Voltage to Drive Rated Voltage +10%.
Rated current is available across the entire Drive Full Power Range

Drive Operating Range = Lowest* Nominal Motor Voltage -10% to Drive Rated Voltage +10%.
Drive Output is linearly derated when Actual Line Voltage is less than the Nominal Motor Voltage

EXAMPLE Calculate the maximum power of a 5 Hp, 460V motor connected to a 480V rated drive supplied with 342V Actual Line Voltage input.

- Actual Line Voltage / Nominal Motor Voltage = 74.3%
- $74.3\% \times 5 \text{ Hp} = 3.7 \text{ Hp}$
- $74.3\% \times 60 \text{ Hz} = 44.6 \text{ Hz}$

At 342V Actual Line Voltage, the maximum power the 5 Hp, 460V motor can produce is 3.7 Hp at 44.6 Hz.

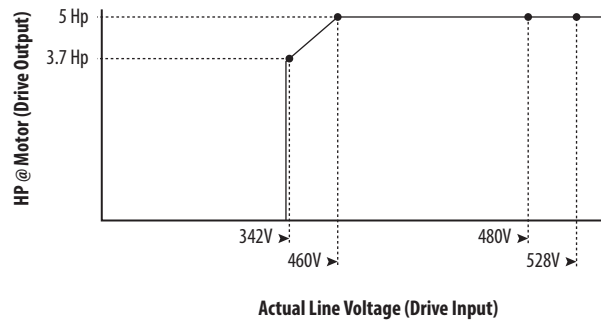

Approximate Watts Loss

The following tables list the watts loss data for drives running at full load, full speed and default carrier frequency.

Internal watts are those dissipated by the control structure of the drive and will be dissipated into the cabinet regardless of mounting style. External watts are those dissipated directly through the heatsink and will be outside the cabinet for flange mount and inside the cabinet for other mounting types.

Watts Loss – Frames 0...6

| Voltage | ND Hp/kW | External Watts | Internal Watts | Total Watts Loss ⁽¹⁾ |
|-----------------------------|----------|----------------|----------------|---------------------------------|
| IP20, NEMA/UL Type 1 | | | | |
| 240V | 0.5 | 9 | 37 | 46 |
| | 1 | 22 | 39 | 61 |
| | 2 | 38 | 39 | 77 |
| | 3 | 57 | 41 | 98 |
| | 5 | 97 | 82 | 179 |
| | 7.5 | 134 | 74 | 208 |
| | 10 | 192 | 77 | 269 |
| | 15 | 276 | 92 | 368 |
| | 20 | 354 | 82 | 436 |
| | 25 | 602 | 96 | 698 |
| | 30 | 780 | 96 | 876 |
| | 40 | 860 | 107 | 967 |
| | 50 | 1132 | 138 | 1270 |
| | 60 | 1296 | 200 | 1496 |
| 75 | 1716 | 277 | 1993 | |
| 100 | 1837 | 418 | 2255 | |
| 400V | 0.37 | 11 | 42 | 53 |
| | 0.75 | 19 | 44 | 63 |
| | 1.5 | 31 | 45 | 76 |
| | 2.2 | 46 | 46 | 93 |
| | 4 | 78 | 87 | 164 |
| | 5.5 | 115 | 79 | 194 |
| | 7.5 | 134 | 84 | 218 |
| | 11 | 226 | 99 | 326 |
| | 15 | 303 | 91 | 394 |
| | 18.5 | 339 | 102 | 441 |
| | 22 | 357 | 103 | 459 |
| | 30 | 492 | 117 | 610 |
| | 37 | 568 | 148 | 717 |
| | 45 | 722 | 207 | 930 |
| 55 | 821 | 286 | 1107 | |
| 55 | 1130 | 397 | 1527 | |

| Voltage | ND Hp/kW | External Watts | Internal Watts | Total Watts Loss⁽¹⁾ |
|---------------------|-----------------|-----------------------|-----------------------|---------------------------------------|
| 400V (continued) | 90 | 1402 | 443 | 1845 |
| | 110 | 1711 | 493 | 2204 |
| | 132 | 1930 | 583 | 2513 |
| 480V | 0.5 | 11 | 42 | 53 |
| | 1 | 19 | 44 | 63 |
| | 2 | 31 | 45 | 76 |
| | 3 | 46 | 46 | 93 |
| | 5 | 78 | 87 | 164 |
| | 7.5 | 115 | 79 | 194 |
| | 10 | 134 | 84 | 218 |
| | 15 | 226 | 99 | 326 |
| | 20 | 303 | 91 | 394 |
| | 25 | 339 | 102 | 441 |
| | 30 | 357 | 103 | 459 |
| | 40 | 492 | 117 | 610 |
| | 50 | 568 | 148 | 717 |
| | 60 | 722 | 207 | 930 |
| | 75 | 821 | 286 | 1107 |
| | 100 | 1130 | 397 | 1527 |
| | 600V | 0.5 | 9 | 37 |
| 1 | | 14 | 40 | 54 |
| 2 | | 25 | 40 | 65 |
| 3 | | 41 | 42 | 83 |
| 5 | | 59 | 83 | 142 |
| 7.5 | | 83 | 75 | 157 |
| 10 | | 109 | 77 | 186 |
| 15 | | 177 | 93 | 270 |
| 20 | | 260 | 83 | 343 |
| 25 | | 291 | 95 | 385 |
| 30 | | 324 | 95 | 419 |
| 40 | | 459 | 109 | 569 |
| 50 | | 569 | 141 | 710 |
| 60 | | 630 | 195 | 825 |
| 75 | | 1053 | 308 | 1361 |
| 100 | 1467 | 407 | 1874 | |
| 125 | 1400 | 500 | 1900 | |
| 150 | 1668 | 612 | 2280 | |

| Voltage | ND Hp/kW | External Watts | Internal Watts | Total Watts Loss ⁽¹⁾ |
|------------------------------|----------|----------------|----------------|---------------------------------|
| IP54, NEMA/UL Type 12 | | | | |
| 480V | 75 | 873 | 234 | 1107 |
| | 100 | 1237 | 290 | 1527 |
| | 125 | 1563 | 282 | 1845 |
| | 150 | 1874 | 330 | 2204 |
| | 200 | 2100 | 413 | 2513 |
| 600V | 75 | 1091 | 270 | 1361 |
| | 100 | 1537 | 337 | 1874 |
| | 125 | 1584 | 316 | 1900 |
| | 150 | 1895 | 385 | 2280 |

(1) Worst case condition including Vector Control board, HIM, and Communication Module.

Watts Loss – Frames 7... 10

| Voltage | Frame | Hp Rating | | Dissipation (Watts) ⁽¹⁾ | | | | | |
|-----------------------------|-------|-----------|-----|------------------------------------|----------|-------|----------|----------|-------|
| | | ND | HD | AC Input | | | DC Input | | |
| | | | | External | Internal | Total | External | Internal | Total |
| IP20, NEMA/UL Type 1 | | | | | | | | | |
| 400/480V | 7 | 250 | 200 | 3422 | 514 | 3936 | 3098 | 497 | 3595 |
| | | 250 | 250 | 4224 | 618 | 4842 | 3848 | 599 | 4447 |
| | 8 | 300 | 250 | 3125 | 569 | 3694 | 2698 | 547 | 3245 |
| | | 350 | 300 | 3588 | 681 | 4269 | 3091 | 655 | 3746 |
| | | 400 | 350 | 4284 | 850 | 5133 | 3692 | 816 | 4510 |
| | | 450 | 400 | 4850 | 1000 | 5850 | 4178 | 965 | 5143 |
| | | 500 | 450 | 5278 | 2010 | 7288 | 4506 | 1969 | 6475 |
| | 9 | 600 | 500 | 8740 | 2270 | 11010 | 7752 | 2218 | 9970 |
| | 10 | 700 | 600 | 8595 | 2339 | 10934 | 7470 | 2280 | 9750 |

(1) Worst case condition including Vector Control board, HIM, and Communication Module.

Derating Guidelines

Altitude and Efficiency

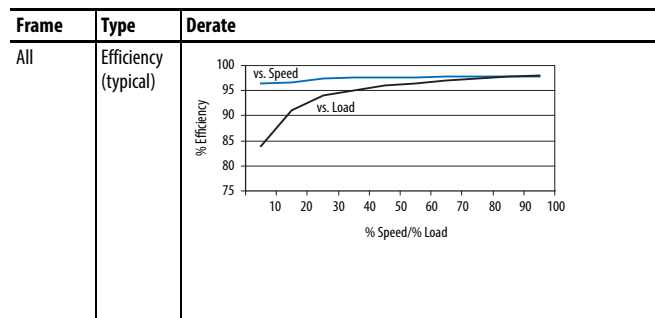
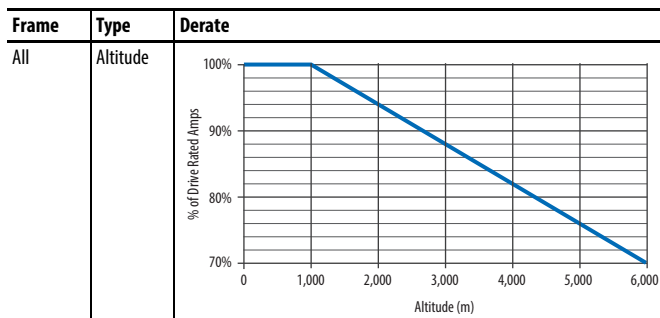

Ambient Temperature/Load – 240V AC

| 240 Volt Power Rating | | | Derating --- 2 kHz - - - 4 kHz — 6 kHz - - - 8 kHz — 10 kHz | 240 Volt Power Rating | | | Derating --- 2 kHz - - - 4 kHz — 6 kHz - - - 8 kHz — 10 kHz |
|-----------------------|------------|------------|--|-----------------------|-------|------------|--|
| ND Hp | HD Hp | Cont. Amps | | ND Hp | HD Hp | Cont. Amps | |
| 0.5...5.0 | 0.33...3.0 | 2.2...15.3 | None | 7.5 | 5.0 | 22 | |
| 10...15 | 7.5...10 | 28...42 | None | 20 | 15 | 52 | |
| 25 | 20 | 70 | | 30 | 25 | 80 | |
| 40 | 30 | 104 (80) | | 50 | 40 | 130 (104) | |
| 60 | 50 | 154 (130) | | 75 | 60 | 192 (154) | |
| 100 | 75 | 260 (205) | | | | | |

Ambient Temperature/Load – 400V AC

| 400 Volt Power Rating | | | Derating --- 2 kHz - - - 4 kHz — 6 kHz - - - 8 kHz — 10 kHz | 400 Volt Power Rating | | | Derating --- 2 kHz - - - 4 kHz — 6 kHz - - - 8 kHz — 10 kHz |
|-----------------------|------------|------------|--|-----------------------|-------|------------|--|
| ND kW | HD kW | Cont. Amps | | ND kW | HD kW | Cont. Amps | |
| 0.37...7.5 | 0.25...5.5 | 1.3...15.4 | None | 11 | 7.5 | 22 | |
| 15 | 11 | 30 | | 18.5 | 15 | 37 | |
| 22 | 18.5 | 43 | None | 30 | 22 | 56 | |
| 37 | 30 | 72 | | 45 | 37 | 85 (72) | |
| 55 | 45 | 105 (85) | | 75 | 55 | 140 (105) | |
| 90 | 75 | 170 (140) | | 110 | 90 | 205 (170) | |
| 132 | 110 | 260 (205) | | 160 | 150 | 292 (263) | see 480 Volt, 292 (263) Amp on page 18 |
| | | | | 180 | 180 | 325 (325) | see 480 Volt, 325 (325) Amp on page 19 |
| | | | | 200 | 180 | 365 (325) | see 480 Volt, 365 (325) Amp on page 19 |
| | | | | 240 | 200 | 415 (365) | see 480 Volt, 415 (365) Amp on page 19 |
| | | | | 280 | 240 | 481 (415) | see 480 Volt, 481 (415) Amp on page 19 |
| | | | | 300 | 280 | 535 (481) | see 480 Volt, 535 (481) Amp on page 19 |
| | | | | 350 | 300 | 600 (535) | see 480 Volt, 600 (535) Amp on page 19 |
| | | | | 400 | 350 | 730 (600) | see 480 Volt, 730 (600) Amp on page 19 |
| | | | | 500 | 400 | 875 (700) | see 480 Volt, 875 (700) Amp on page 19 |

Ambient Temperature/Load – 480V AC

| 480 Volt Power Rating | | | Derating --- 2 kHz - - - 4 kHz — 6 kHz - - - 8 kHz — 10 kHz |
|-----------------------|------------|------------|--|
| ND Hp | HD Hp | Cont. Amps | |
| 0.5...10 | 0.33...7.5 | 1.1...14 | None |
| 20 | 15 | 27 | |
| 30 | 25 | 40 | None |
| 50 | 40 | 65 | |
| 75 | 60 | 96 (77) | |
| 125 | 100 | 156 (125) | |
| 200 | 150 | 248 (180) | |

| 480 Volt Power Rating | | | Derating --- 2 kHz - - - 4 kHz — 6 kHz - - - 8 kHz — 10 kHz |
|-----------------------|-------|------------|--|
| ND Hp | HD Hp | Cont. Amps | |
| 15 | 10 | 22 | |
| 25 | 20 | 34 | |
| 40 | 30 | 52 | |
| 60 | 50 | 77 (65) | |
| 100 | 75 | 125 (96) | |
| 150 | 125 | 180 (156) | |
| 250 | 200 | 292 (263) | |

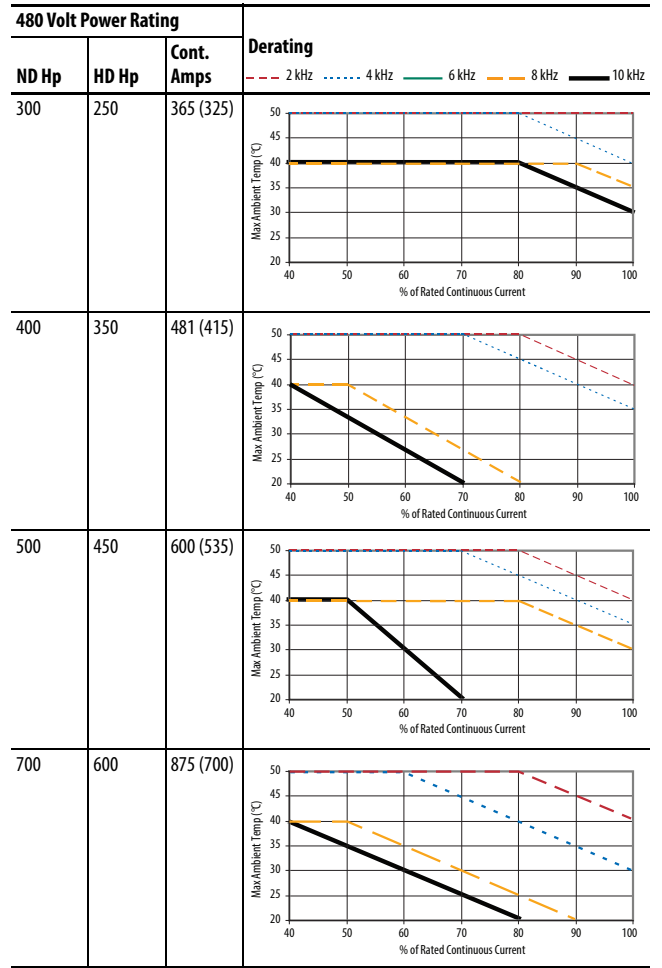
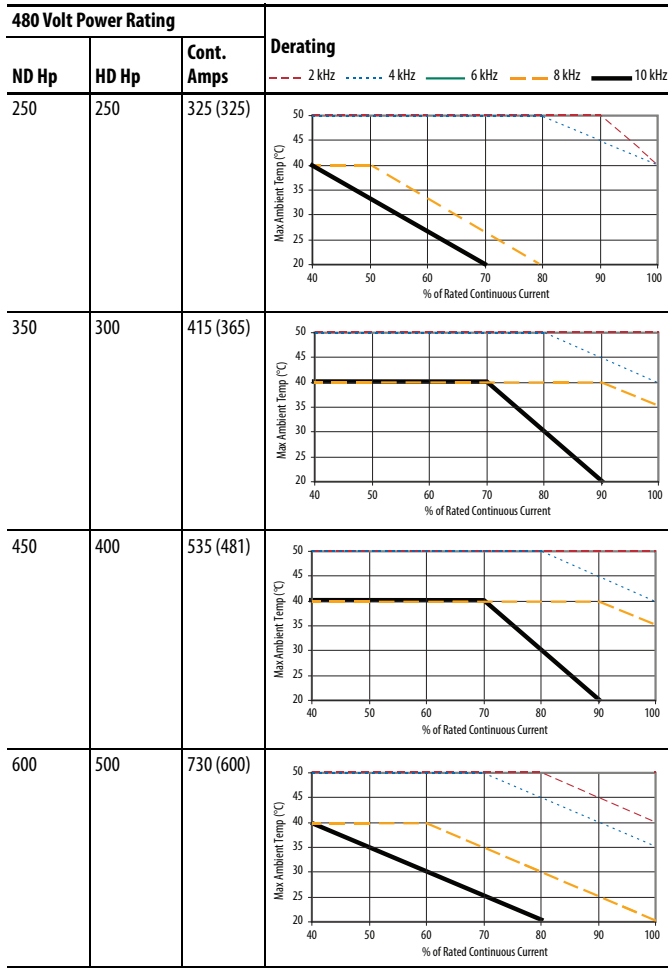

Ambient Temperature/Load – 600V AC

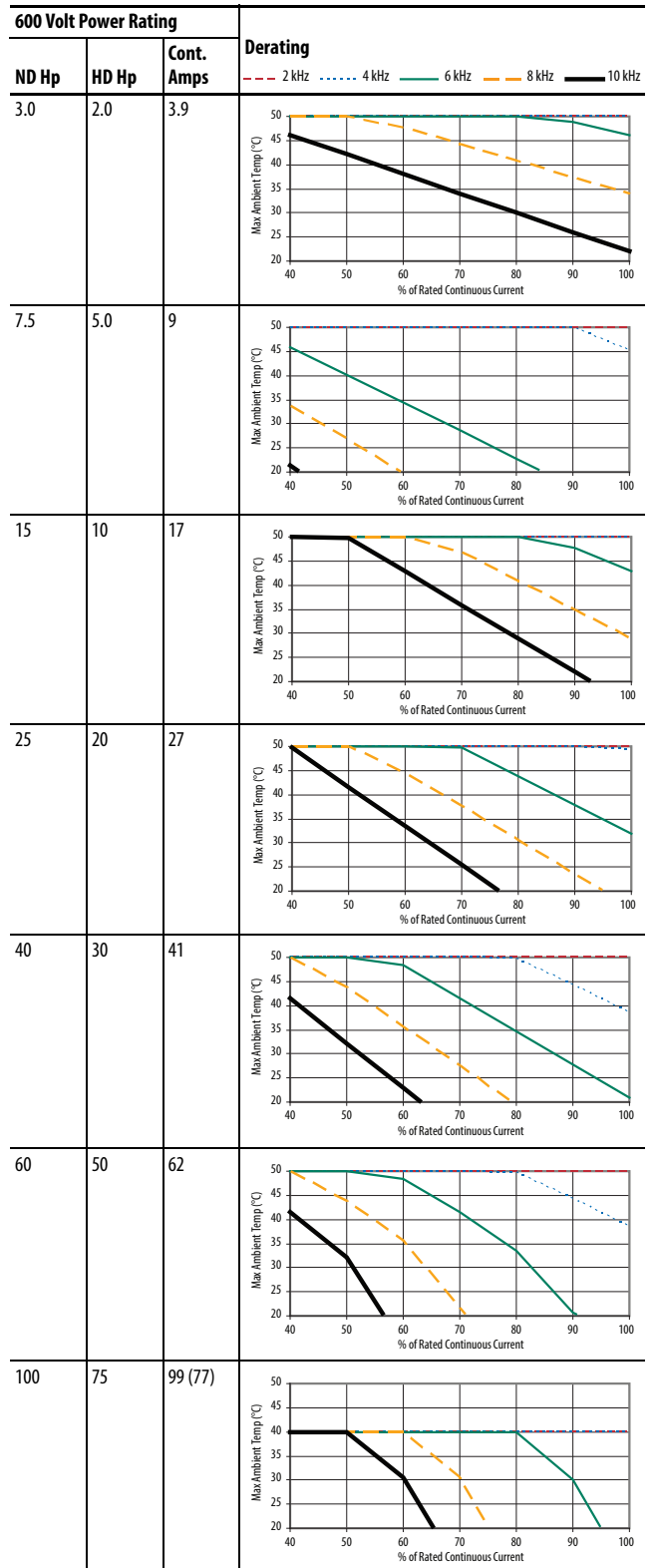
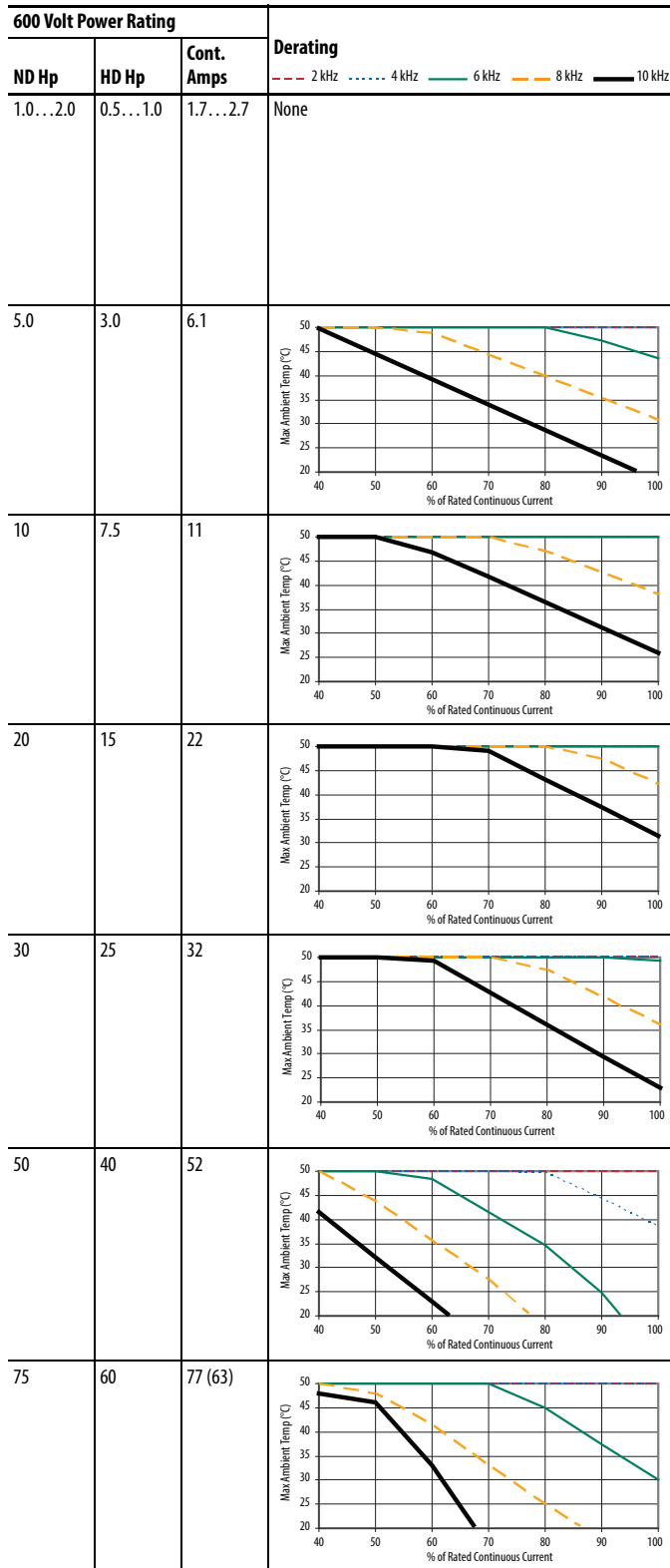

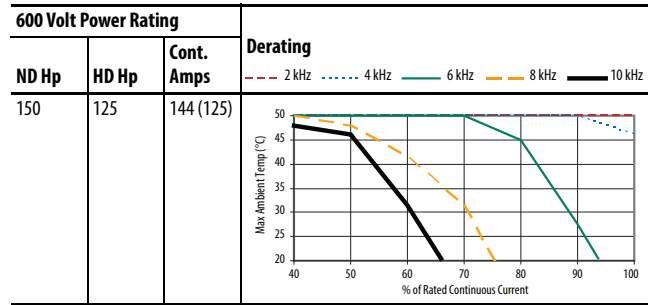
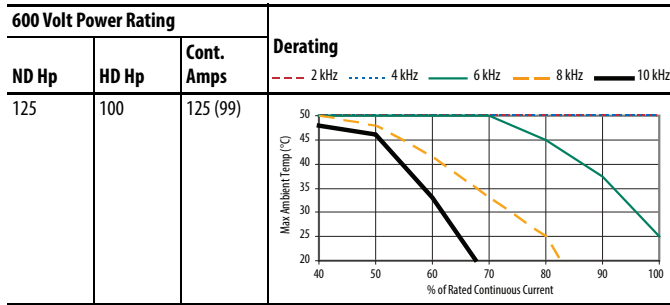

Ambient Temperature/Load – 690V AC

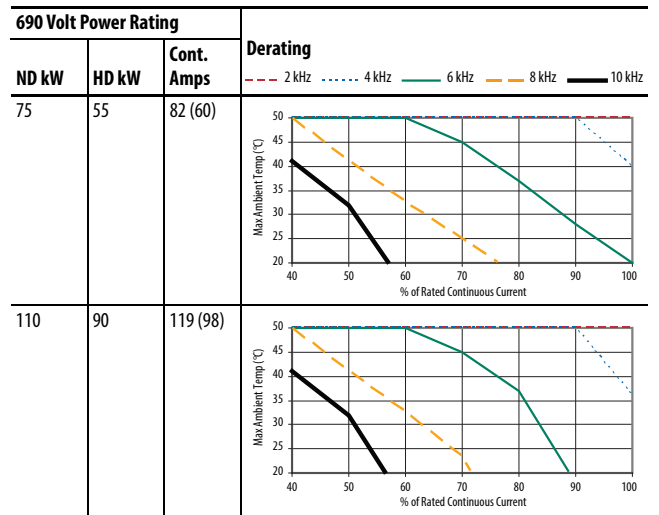
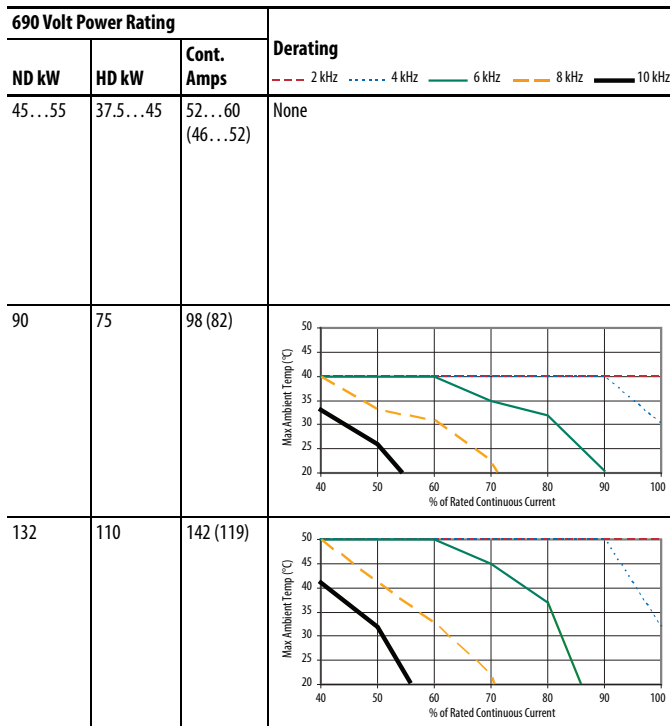

Single-Phase Input Power

The PowerFlex 700 drive is typically used with a three-phase input supply. Single-phase operation is possible with output current derated by 50% (at maximum ambient temperature of 25 °C) of the three-phase ratings.

208/240 Volt Single-Phase AC Input Ratings

| 240V Single-Phase AC Input | | | | | | 208V Single-Phase AC Input | | | | | | Temp. °C |
|----------------------------|-------|-----------|------------|--------------------|------|----------------------------|-------|-----------|------------|--------------------|-------|-------------|
| Drive Catalog Number | Frame | Hp Rating | Input Amps | Three-Phase Output | | Drive Catalog Number | Frame | Hp Rating | Input Amps | Three-Phase Output | | |
| | | | | V AC | Amps | | | | | V AC | Amps | |
| 20BB2P2 | 0 | 0.25 | 1.5 | 0-230 | 1.1 | 20BB2P2 | 0 | 0.25 | 1.7 | 0-200 | 1.3 | 25 |
| 20BB4P2 | 0 | 0.5 | 2.8 | 0-230 | 2.1 | 20BB4P2 | 0 | 0.5 | 3.2 | 0-200 | 2.4 | 25 |
| 20BB6P8 | 1 | 1 | 5.1 | 0-230 | 3.4 | 20BB6P8 | 1 | 1 | 5.9 | 0-200 | 3.9 | 25 |
| 20BB9P6 | 1 | 1.5 | 7.2 | 0-230 | 4.8 | 20BB9P6 | 1 | 1.5 | 8.3 | 0-200 | 5.5 | 25 |
| 20BB015 | 1 | 2.5 | 11.9 | 0-230 | 7.7 | 20BB015 | 1 | 2.5 | 13.6 | 0-200 | 8.8 | 25 |
| 20BB022 | 1 | 3.75 | 17.3 | 0-230 | 11 | 20BB022 | 1 | 3.75 | 19.9 | 0-200 | 12.7 | 25 |
| 20BB028 | 2 | 5 | 22.2 | 0-230 | 14 | 20BB028 | 2 | 5 | 25.7 | 0-200 | 16.1 | 25 |
| 20BB042 | 3 | 7.5 | 33.4 | 0-230 | 21 | 20BB042 | 3 | 7.5 | 38.5 | 0-200 | 24.2 | 25 |
| 20BB052 | 3 | 10 | 41.3 | 0-230 | 26 | 20BB052 | 3 | 10 | 44.6 | 0-200 | 28 | 25 |
| 20BB070 | 4 | 12.5 | 55.6 | 0-230 | 35 | 20BB070 | 4 | 12.5 | 62.3 | 0-200 | 39.1 | 25 |
| 20BB080 | 4 | 15 | 63.6 | 0-230 | 40 | 20BB080 | 4 | 15 | 73.3 | 0-200 | 46 | 25 |
| 20BB104 | 5 | 20 | 84.6 | 0-230 | 52 | 20BB104 | 5 | 20 | 97.9 | 0-200 | 60 | 25 |
| 20BB130 | 5 | 25 | 105.7 | 0-230 | 65 | 20BB130 | 5 | 25 | 106.1 | 0-200 | 65 | 25 |
| 20BB154 | 6 | 30 | 125.2 | 0-230 | 77 | 20BB154 | 6 | 30 | 144.4 | 0-200 | 88.5 | 25 |
| 20BB192 | 6 | 37.5 | 156.1 | 0-230 | 96 | 20BB192 | 6 | 37.5 | 180.3 | 0-200 | 110.5 | 25 |
| 20BB260 | 6 | 50 | 211.4 | 0-230 | 130 | 20BB260 | 6 | 50 | 212.1 | 0-200 | 130 | 25 |

380...480 Volt Single-Phase AC Input Ratings

| 480V Single-Phase AC Input | | | | | | 380...400V Single-Phase AC Input | | | | | | Temp. °C |
|----------------------------|-------|-----------|------------|--------------------|------|----------------------------------|-------|-----------|------------|--------------------|-------|-------------|
| Drive Catalog Number | Frame | Hp Rating | Input Amps | Three-Phase Output | | Drive Catalog Number | Frame | kW Rating | Input Amps | Three-Phase Output | | |
| | | | | V AC | Amps | | | | | V AC | Amps | |
| 20BD1P1 | 0 | 0.25 | 0.7 | 0-460 | 0.6 | 20BC1P3 | 0 | 0.2 | 1 | 0-400 | 0.7 | 25 |
| 20BD2P1 | 0 | 0.5 | 1.4 | 0-460 | 1.1 | 20BC2P1 | 0 | 0.4 | 1.6 | 0-400 | 1.1 | 25 |
| 20BD3P4 | 0 | 1 | 2.3 | 0-460 | 1.7 | 20BC3P5 | 0 | 0.75 | 2.7 | 0-400 | 1.8 | 25 |
| 20BD5P0 | 0 | 1.5 | 3.4 | 0-460 | 2.5 | 20BC5P0 | 0 | 1.1 | 3.9 | 0-400 | 2.5 | 25 |
| 20BD8P0 | 0 | 2.5 | 6 | 0-460 | 4 | 20BC8P7 | 0 | 2 | 6.9 | 0-400 | 4.4 | 25 |
| 20BD011 | 0 | 3.75 | 8.2 | 0-460 | 5.5 | 20BC011 | 0 | 2.75 | 9.3 | 0-400 | 5.8 | 25 |
| 20BD014 | 1 | 5 | 10.9 | 0-460 | 7 | 20BC015 | 1 | 3.75 | 12.5 | 0-400 | 7.7 | 25 |
| 20BD022 | 1 | 7.5 | 17.3 | 0-460 | 11 | 20BC022 | 1 | 5.5 | 17.8 | 0-400 | 11 | 25 |
| 20BD027 | 2 | 10 | 21.4 | 0-460 | 13.5 | 20BC030 | 2 | 7.5 | 24.6 | 0-400 | 15 | 25 |
| 20BD034 | 2 | 12.5 | 27 | 0-460 | 17 | 20BC037 | 2 | 9.25 | 30.3 | 0-400 | 18.5 | 25 |
| 20BD040 | 3 | 15 | 31.8 | 0-460 | 20 | 20BC043 | 3 | 11 | 35.2 | 0-400 | 21.5 | 25 |
| 20BD052 | 3 | 20 | 41.3 | 0-460 | 26 | 20BC056 | 3 | 15 | 45.9 | 0-400 | 28 | 25 |
| 20BD065 | 3 | 25 | 51.6 | 0-460 | 32.5 | 20BC072 | 3 | 18.5 | 59.7 | 0-400 | 36 | 25 |
| 20BD077 | 4 | 30 | 62.6 | 0-460 | 38.5 | 20BC085 | 4 | 22.5 | 70.5 | 0-400 | 42.5 | 25 |
| 20BD096 | 5 | 37.5 | 78.1 | 0-460 | 48 | 20BC105 | 5 | 27.5 | 87 | 0-400 | 52.5 | 25 |
| 20BD125 | 5 | 50 | 101.6 | 0-460 | 62.5 | 20BC125 | 5 | 27.5 | 103.6 | 0-400 | 62.5 | 25 |
| – | – | – | – | – | – | 20BC140 | 5 | 37.5 | 117.4 | 0-400 | 70 | 25 |
| 20BD156 | 6 | 62.5 | 126.8 | 0-460 | 78 | 20BC170 | 6 | 45 | 142.6 | 0-400 | 85 | 25 |
| 20BD180 | 6 | 75 | 146.4 | 0-460 | 90 | 20BC205 | 6 | 55 | 171.9 | 0-400 | 102.5 | 25 |
| 20BD248 | 6 | 100 | 201.6 | 0-460 | 124 | 20BC260 | 6 | 66 | 220.6 | 0-400 | 130 | 25 |

600...690 Volt Single-Phase AC Input Rating

| 600V Single-Phase AC Input | | | | | | 690V Single-Phase AC Input | | | | | | Temp. °C |
|----------------------------|-------|--------------|---------------|-----------------------|------|----------------------------|-------|--------------|---------------|-----------------------|------|-------------|
| Drive Catalog Number | Frame | Hp Rating | Input Amps | Three-Phase Output | | Drive Catalog Number | Frame | kW Rating | Input Amps | Three-Phase Output | | |
| | | | | V AC | Amps | | | | | V AC | Amps | |
| 20BE1P7 | 0 | 0.5 | 1.1 | 0-575 | 0.9 | — | — | — | — | — | — | 25 |
| 20BE2P7 | 0 | 1 | 1.8 | 0-575 | 1.4 | — | — | — | — | — | — | 25 |
| 20BE3P9 | 0 | 1.5 | 2.6 | 0-575 | 2 | — | — | — | — | — | — | 25 |
| 20BE6P1 | 0 | 2.5 | 4.6 | 0-575 | 3.1 | — | — | — | — | — | — | 25 |
| 20BE9P0 | 0 | 3.75 | 6.7 | 0-575 | 4.5 | — | — | — | — | — | — | 25 |
| 20BE011 | 1 | 5 | 8.5 | 0-575 | 5.5 | — | — | — | — | — | — | 25 |
| 20BE017 | 1 | 7.5 | 13.3 | 0-575 | 8.5 | — | — | — | — | — | — | 25 |
| 20BE022 | 2 | 10 | 17.5 | 0-575 | 11 | — | — | — | — | — | — | 25 |
| 20BE027 | 2 | 12.5 | 21.4 | 0-575 | 13.5 | — | — | — | — | — | — | 25 |
| 20BE032 | 3 | 15 | 25.4 | 0-575 | 16 | — | — | — | — | — | — | 25 |
| 20BE041 | 3 | 20 | 32.6 | 0-575 | 20.5 | — | — | — | — | — | — | 25 |
| 20BE052 | 3 | 25 | 41.3 | 0-575 | 26 | 20BF052 | 5 | 22.5 | 43.1 | 0-690 | 26 | 25 |
| 20BE062 | 4 | 30 | 50.4 | 0-575 | 31 | 20BF060 | 5 | 27.5 | 49.9 | 0-690 | 30 | 25 |
| 20BE077 | 5 | 37.5 | 62.6 | 0-575 | 38.5 | 20BF082 | 5 | 37.5 | 68.4 | 0-690 | 41 | 25 |
| 20BE099 | 5 | 50 | 80.5 | 0-575 | 49.5 | 20BF098 | 5 | 45 | 82 | 0-690 | 49 | 25 |
| 20BE125 | 6 | 62.5 | 101.6 | 0-575 | 62.5 | 20BF119 | 6 | 55 | 100 | 0-690 | 59.5 | 25 |
| 20BE144 | 6 | 75 | 117.1 | 0-575 | 72 | 20BF142 | 6 | 66 | 120.2 | 0-690 | 71 | 25 |

Drive, Fuse and Circuit Breaker Ratings

The PowerFlex 700 can be installed with input fuses or an input circuit breaker. National and local industrial safety regulations and/or electrical codes can determine additional requirements for these installations.

The tables on the following pages provide recommended AC line input fuse and circuit breaker information. See Fusing and Circuit Breakers below for UL and IEC requirements. Sizes listed are the recommended sizes based on 40 °C (104 °F) and the U.S. NEC. Other country, state, or local codes can require different ratings. Tables with DC link fuse recommendations for DC input drives are also provided.

Fusing

The recommended fuse types are listed below. If available current ratings do not match those listed in the tables provided, choose the next higher fuse rating.

- IEC – BS88 (British Standard) Parts 1 & 2, EN60269-1, Parts 1 & 2⁽¹⁾, type gG or equivalent must be used.
- UL – UL Class CC, T, RK1 or J must be used for Frames 0...6.
UL Class T, RK1, J, or L must be used for Frames 7...10.

Circuit Breakers

The “non-fuse” listings in the following tables include inverse time circuit breakers, instantaneous trip circuit breakers (motor circuit protectors) and 140M self-protected combination motor controllers (Frames 0...6 only). If one of these is chosen as the desired protection method, the following requirements apply:

- IEC – Both types of circuit breakers and 140M self-protected combination motor controllers (Frames 0...6 only) are acceptable for IEC installations.
- UL – Only inverse time circuit breakers and the specified 140M self-protected combination motor controllers (Frames 0...6 only) are acceptable for UL installations.

(1) Typical designations include, but may not be limited to the following; Parts 1 & 2: AC, AD, BC, BD, CD, DD, ED, EFS, EF, FF, FG, GF, GG, GH.

208 Volt AC Input Protection Devices – Frames 0...6

| Drive Catalog Number | Frame | Hp Rating | | PWM Freq. | Temp. (11) | Input Ratings | | Output Amps | | | Dual Element Time Delay Fuse | | Non-Time Delay Fuse | | Circuit Breaker (3) | Motor Circuit Protector (4) | 140M Motor Protector with Adjustable Current Range (5)(6) | | | Min. Enclosure Vol. (in. 3) (14) |
|----------------------|-------|-----------|------|-----------|------------|---------------|------|-------------|--------|--------|------------------------------|----------|---------------------|----------|---------------------|-----------------------------|---|-----------|-----------|----------------------------------|
| | | ND | HD | kHz | °C | Amps | kVA | Cont. | 1 Min. | 3 Sec. | Min. (1) | Max. (2) | Min. (1) | Max. (2) | Max. (8) | Max. (8) | Available Catalog Numbers - 140... (7) | | | |
| 20BB2P2 | 0 | 0.5 | 0.33 | 4 | 50 | 1.9 | 0.7 | 2.5 | 2.8 | 3.8 | 3 | 6 | 3 | 10 | 15 | 3 | M-C2E-B25 | M-D8E-B25 | — | 7269 |
| 20BB4P2 | 0 | 1 | 0.75 | 4 | 50 | 3.7 | 1.3 | 4.8 | 5.6 | 7 | 6 | 10 | 6 | 17.5 | 15 | 7 | M-C2E-B63 | M-D8E-B63 | — | 7269 |
| 20BB6P8 | 1 | 2 | 1.5 | 4 | 50 | 6.8 | 2.4 | 7.8 | 10.4 | 13.8 | 10 | 15 | 10 | 30 | 30 | 15 | M-C2E-C10 | M-D8E-C10 | M-F8E-C10 | 7269 |
| 20BB9P6 | 1 | 3 | 2 | 4 | 50 | 9.5 | 3.4 | 11 | 12.1 | 17 | 12 | 20 | 12 | 40 | 40 | 15 | M-C2E-C16 | M-D8E-C16 | M-F8E-C16 | 7269 |
| 20BB015 | 1 | 5 | 3 | 4 | 50 | 15.7 | 5.7 | 17.5 | 19.3 | 26.3 | 20 | 35 | 20 | 70 | 70 | 30 | M-C2E-C20 | M-D8E-C20 | M-F8E-C20 | 7269 |
| 20BB022 | 1 | 7.5 | 5 | 4 | 50 | 23 | 8.3 | 25.3 | 27.8 | 38 | 30 | 50 | 30 | 100 | 100 | 30 | — | M-D8E-C25 | M-F8E-C25 | 7269 |
| 20BB028 | 2 | 10 | 7.5 | 4 | 50 | 29.6 | 10.7 | 32.2 | 38 | 50.6 | 40 | 70 | 40 | 125 | 125 | 50 | — | — | M-F8E-C32 | 7269 |
| 20BB042 | 3 | 15 | 10 | 4 | 50 | 44.5 | 16 | 48.3 | 53.1 | 72.5 | 60 | 100 | 60 | 175 | 175 | 70 | — | — | M-F8E-C45 | 13630 |
| 20BB052 | 3 | 20 | 15 | 4 | 50 | 51.5 | 17.1 | 56 | 64 | 86 | 80 | 125 | 80 | 200 | 200 | 100 | — | — | — | — |
| 20BB070 | 4 | 25 | 20 | 4 | 50 | 72 | 25.9 | 78.2 | 93 | 124 | 90 | 175 | 90 | 300 | 300 | 100 | — | — | — | — |
| 20BB080 | 4 | 30 | 25 | 4 | 50 | 84.7 | 30.5 | 92 | 117 | 156 | 110 | 200 | 110 | 350 | 350 | 150 | — | — | — | — |
| 20BB104 (12) | 5 | 40 | — | 4 | 50 | 113 | 40.7 | 120 | 132 | 175 | 150 | 250 | 150 | 475 | 350 | 150 | — | — | — | — |
| | | — | 30 | 4 | 50 | 84.7 | 30.5 | 92 | 138 | 175 | 125 | 200 | 125 | 350 | 300 | 150 | — | — | — | — |
| 20BB130 (12)(12) | 5 | 50 | — | 4 | 50 | 141 | 44.1 | 130 | 143 | 175 | 175 | 275 | 175 | 500 | 375 | 250 | — | — | — | — |
| | | — | 40 | 4 | 50 | 113 | 35.3 | 104 | 156 | 175 | 125 | 225 | 125 | 400 | 300 | 150 | — | — | — | — |
| 20BB154 (12) | 6 | 60 | — | 4 | 50 | 167 | 60.1 | 177 | 195 | 266 | 225 | 350 | 225 | 500 | 500 | 250 | — | — | — | — |
| | | — | 50 | 4 | 50 | 141 | 50.9 | 150 | 225 | 300 | 200 | 300 | 200 | 500 | 450 | 250 | — | — | — | — |
| 20BB192 (12) | 6 | 75 | — | 4 | 50 | 208 | 75 | 221 | 243 | 308 | 300 | 450 | 300 | 600 | 600 | 400 | — | — | — | — |
| | | — | 60 | 4 | 50 | 167 | 60.1 | 177 | 266 | 308 | 225 | 350 | 225 | 500 | 500 | 250 | — | — | — | — |
| 20BB260 (12) | 6 | 100 | — | 2 | 45 | 255 | 91.9 | 260 | 286 | 390 | 300 | 575 | 300 | 750 | 750 | 400 | — | — | — | — |
| | | — | 75 | 2 | 50 | 199 | 71.7 | 205 | 305 | 410 | 225 | 450 | 225 | 600 | 600 | 400 | — | — | — | — |

See page 29 for notes.

240 Volt AC Input Protection Devices – Frames 0...6

| Drive Catalog Number | Frame | Hp Rating | | PWM Freq. | Temp. (11) | Input Ratings | | Output Amps | | | Dual Element Time Delay Fuse | | Non-Time Delay Fuse | | Circuit Breaker (3) | Motor Circuit Protector (4) | 140M Motor Protector with Adjustable Current Range (5)(6) | | | Min. Enclosure Vol. (in. 3) (14) |
|----------------------|-------|-----------|------|-----------|------------|---------------|------|-------------|--------|--------|------------------------------|----------|---------------------|----------|---------------------|-----------------------------|---|-----------|-----------|----------------------------------|
| | | ND | HD | kHz | °C | Amps | kVA | Cont. | 1 Min. | 3 Sec. | Min. (1) | Max. (2) | Min. (1) | Max. (2) | Max. (8) | Max. (8) | Available Catalog Numbers - 140... (7) | | | |
| 20BB2P2 | 0 | 0.5 | 0.33 | 4 | 50 | 1.7 | 0.7 | 2.2 | 2.4 | 3.3 | 3 | 6 | 3 | 10 | 15 | 3 | M-C2E-B25 | M-D8E-B25 | — | 7269 |
| 20BB4P2 | 0 | 1 | 0.75 | 4 | 50 | 3.3 | 1.4 | 4.2 | 4.8 | 6.4 | 5 | 8 | 5 | 15 | 15 | 7 | M-C2E-B63 | M-D8E-B63 | — | 7269 |
| 20BB6P8 | 1 | 2 | 1.5 | 4 | 50 | 5.9 | 2.4 | 6.8 | 9 | 12 | 10 | 15 | 10 | 25 | 25 | 15 | M-C2E-C10 | M-D8E-C10 | M-F8E-C10 | 7269 |
| 20BB9P6 | 1 | 3 | 2 | 4 | 50 | 8.3 | 3.4 | 9.6 | 10.6 | 14.4 | 12 | 20 | 12 | 35 | 35 | 15 | M-C2E-C10 | M-D8E-C10 | M-F8E-C10 | 7269 |
| 20BB015 | 1 | 5 | 3 | 4 | 50 | 13.7 | 5.7 | 15.3 | 16.8 | 23 | 20 | 30 | 20 | 60 | 60 | 30 | M-C2E-C16 | M-D8E-C16 | M-F8E-C16 | 7269 |
| 20BB022 | 1 | 7.5 | 5 | 4 | 50 | 19.9 | 8.3 | 22 | 24.2 | 33 | 25 | 50 | 25 | 80 | 80 | 30 | — | M-D8E-C25 | M-F8E-C25 | 7269 |
| 20BB028 | 2 | 10 | 7.5 | 4 | 50 | 25.7 | 10.7 | 28 | 33 | 44 | 35 | 60 | 35 | 100 | 100 | 50 | — | — | M-F8E-C32 | 7269 |
| 20BB042 | 3 | 15 | 10 | 4 | 50 | 38.5 | 16 | 42 | 46.2 | 63 | 50 | 90 | 50 | 150 | 150 | 50 | — | — | M-F8E-C45 | 13630 |
| 20BB052 | 3 | 20 | 15 | 4 | 50 | 47.7 | 19.8 | 52 | 63 | 80 | 60 | 100 | 60 | 200 | 200 | 100 | — | — | — | — |
| 20BB070 | 4 | 25 | 20 | 4 | 50 | 64.2 | 26.7 | 70 | 78 | 105 | 90 | 150 | 90 | 275 | 275 | 100 | — | — | — | — |
| 20BB080 | 4 | 30 | 25 | 4 | 50 | 73.2 | 30.5 | 80 | 105 | 140 | 100 | 180 | 100 | 300 | 300 | 100 | — | — | — | — |
| 20BB104 (12) | 5 | 40 | — | 4 | 50 | 98 | 40.6 | 104 | 115 | 175 | 125 | 225 | 125 | 400 | 300 | 150 | — | — | — | — |
| | | — | 30 | 4 | 50 | 73 | 30.5 | 80 | 120 | 160 | 100 | 175 | 100 | 300 | 300 | 100 | — | — | — | — |
| 20BB130 (12) | 5 | 50 | — | 4 | 50 | 122 | 50.7 | 130 | 143 | 175 | 175 | 275 | 175 | 500 | 375 | 250 | — | — | — | — |
| | | — | 40 | 4 | 50 | 98 | 40.6 | 104 | 156 | 175 | 125 | 225 | 125 | 400 | 300 | 150 | — | — | — | — |
| 20BB154 (12) | 6 | 60 | — | 4 | 50 | 145 | 60.1 | 154 | 169 | 231 | 200 | 300 | 200 | 600 | 450 | 250 | — | — | — | — |
| | | — | 50 | 4 | 50 | 122 | 50.7 | 130 | 195 | 260 | 175 | 275 | 175 | 500 | 375 | 250 | — | — | — | — |
| 20BB192 (12) | 6 | 75 | — | 4 | 50 | 180 | 74.9 | 192 | 211 | 288 | 225 | 400 | 225 | 600 | 575 | 250 | — | — | — | — |
| | | — | 60 | 4 | 50 | 145 | 60.1 | 154 | 231 | 308 | 200 | 300 | 200 | 600 | 450 | 250 | — | — | — | — |
| 20BB260 (12) | 6 | 100 | — | 2 | 45 | 233 | 96.7 | 260 | 286 | 390 | 300 | 575 | 300 | 750 | 750 | 300 | — | — | — | — |
| | | — | 75 | 2 | 50 | 169 | 70.1 | 205 | 305 | 410 | 225 | 450 | 225 | 600 | 600 | 250 | — | — | — | — |

See page 29 for notes.

400 Volt AC Input Protection Devices – Frames 0...6

| Drive Catalog Number | Frame | kW Rating | | PWM Freq. | Temp. | Input Ratings | | Output Amps | | | Dual Element Time Delay Fuse | | Non-Time Delay Fuse | | Circuit Breaker (3) | Motor Circuit Protector (4) | 140M Motor Protector with Adjustable Current Range (5)(6) | | | |
|----------------------|-------|-----------|------|-----------|------------------------|---------------|------|-------------|--------|--------|------------------------------|----------|---------------------|----------|---------------------|-----------------------------|---|-----------|-----------|----------------------------------|
| | | ND | HD | kHz | °C | Amps | kVA | Cont. | 1 Min. | 3 Sec. | Min. (1) | Max. (2) | Min. (1) | Max. (2) | Max. (8) | Max. (8) | Available Catalog Numbers - 140... (7) | | | Min. Enclosure Vol. (in. 3) (14) |
| 20BC1P3 | 0 | 0.37 | 0.25 | 4 | 50 ⁽¹¹⁾ | 1.1 | 0.77 | 1.3 | 1.4 | 1.9 | 3 | 3 | 3 | 6 | 15 | 3 | M-C2E-B16 | – | – | 7269 |
| 20BC2P1 | 0 | 0.75 | 0.55 | 4 | 50 ⁽¹¹⁾ | 1.8 | 1.3 | 2.1 | 2.4 | 3.2 | 3 | 6 | 3 | 8 | 15 | 3 | M-C2E-B25 | M-D8E-B25 | – | 7269 |
| 20BC3P5 | 0 | 1.5 | 0.75 | 4 | 50 ⁽¹¹⁾ | 3.2 | 2.2 | 3.5 | 4.5 | 6 | 6 | 7 | 6 | 12 | 15 | 7 | M-C2E-B40 | M-D8E-B40 | – | 7269 |
| 20BC5P0 | 0 | 2.2 | 1.5 | 4 | 50 ⁽¹¹⁾ | 4.6 | 3.2 | 5 | 5.5 | 7.5 | 6 | 10 | 6 | 20 | 20 | 7 | M-C2E-B63 | M-D8E-B63 | – | 7269 |
| 20BC8P7 | 0 | 4 | 2.2 | 4 | 50 ⁽¹¹⁾ | 7.9 | 5.5 | 8.7 | 9.9 | 13.2 | 15 | 17.5 | 15 | 30 | 30 | 15 | M-C2E-C10 | M-D8E-C10 | M-F8E-C10 | 7269 |
| 20BC011 | 0 | 5.5 | 4 | 4 | 50 ⁽¹¹⁾ | 10.8 | 7.5 | 11.5 | 13 | 17.4 | 15 | 25 | 15 | 45 | 45 | 15 | M-C2E-C16 | M-D8E-C16 | M-F8E-C16 | 7269 |
| 20BC015 | 1 | 7.5 | 5.5 | 4 | 50 ⁽¹¹⁾ | 14.4 | 10 | 15.4 | 17.2 | 23.1 | 20 | 30 | 20 | 60 | 60 | 20 | M-C2E-C20 | M-D8E-C20 | M-F8E-C20 | 7269 |
| 20BC022 | 1 | 11 | 7.5 | 4 | 50 ⁽¹¹⁾ | 20.6 | 14.3 | 22 | 24.2 | 33 | 30 | 45 | 30 | 80 | 80 | 30 | – | M-D8E-C25 | M-F8E-C25 | 7269 |
| 20BC030 | 2 | 15 | 11 | 4 | 50 ⁽¹¹⁾ | 28.4 | 19.7 | 30 | 33 | 45 | 35 | 60 | 35 | 120 | 120 | 50 | – | – | M-F8E-C32 | 7269 |
| 20BC037 | 2 | 18.5 | 15 | 4 | 50 ⁽¹¹⁾ | 35 | 24.3 | 37 | 45 | 60 | 45 | 80 | 45 | 125 | 125 | 50 | – | – | M-F8E-C45 | 7269 |
| 20BC043 | 3 | 22 | 18.5 | 4 | 50 ⁽¹¹⁾ | 40.7 | 28.2 | 43 | 56 | 74 | 60 | 90 | 60 | 150 | 150 | 60 | – | – | – | – |
| 20BC056 | 3 | 30 | 22 | 4 | 50 ⁽¹¹⁾ | 53 | 36.7 | 56 | 64 | 86 | 70 | 125 | 70 | 200 | 200 | 100 | – | – | – | – |
| 20BC072 | 3 | 37 | 30 | 4 | 50 ⁽¹⁰⁾⁽¹¹⁾ | 68.9 | 47.8 | 72 | 84 | 112 | 90 | 150 | 90 | 250 | 250 | 100 | – | – | – | – |
| 20BC085 (12) | 4 | 45 | – | 4 | 45 ⁽¹¹⁾ | 81.4 | 56.4 | 85 | 94 | 128 | 110 | 200 | 110 | 300 | 300 | 150 | – | – | – | – |
| | | – | 37 | 4 | 45 ⁽¹¹⁾ | 68.9 | 47.8 | 72 | 108 | 144 | 90 | 175 | 90 | 275 | 300 | 100 | – | – | – | – |
| 20BC105 (12) | 5 | 55 | – | 4 | 50 ⁽⁹⁾ | 100.5 | 69.6 | 105 | 116 | 158 | 125 | 225 | 125 | 400 | 300 | 150 | – | – | – | – |
| | | – | 45 | 4 | 50 ⁽⁹⁾ | 81.4 | 56.4 | 85 | 128 | 170 | 110 | 175 | 110 | 300 | 300 | 150 | – | – | – | – |
| 20BC125 (12) | 5 | 55 | – | 4 | 50 ⁽⁹⁾ | 121.1 | 83.9 | 125 | 138 | 163 | 150 | 275 | 150 | 500 | 375 | 250 | – | – | – | – |
| | | – | 45 | 4 | 50 ⁽⁹⁾ | 91.9 | 63.7 | 96 | 144 | 168 | 125 | 200 | 125 | 375 | 375 | 150 | – | – | – | – |
| 20BC140 (12) | 5 | 75 | – | 4 | 40 ⁽⁹⁾ | 136 | 93.9 | 140 | 154 | 190 | 200 | 300 | 200 | 400 | 400 | 250 | – | – | – | – |
| | | – | 55 | 4 | 40 ⁽⁹⁾ | 101 | 69.6 | 105 | 157 | 190 | 150 | 225 | 150 | 300 | 300 | 150 | – | – | – | – |
| 20BC170 (12) | 6 | 90 | – | 4 | 50 ⁽⁹⁾ | 164 | 126 | 170 | 187 | 255 | 250 | 375 | 250 | 600 | 500 | 250 | – | – | – | – |
| | | – | 75 | 4 | 50 ⁽⁹⁾ | 136 | 103 | 140 | 210 | 280 | 200 | 300 | 200 | 550 | 400 | 250 | – | – | – | – |
| 20BC205 (12) | 6 | 110 | – | 4 | 40 ⁽⁹⁾ | 199 | 148 | 205 | 220 | 289 | 250 | 450 | 250 | 600 | 600 | 400 | – | – | – | – |
| | | – | 90 | 4 | 40 ⁽⁹⁾ | 164 | 126 | 170 | 255 | 313 | 250 | 375 | 250 | 600 | 500 | 250 | – | – | – | – |
| 20BC260 (12) | 6 | 132 | – | 2 | 45 ⁽⁹⁾ | 255 | 177 | 260 | 286 | 390 | 350 | 550 | 350 | 750 | 750 | 400 | – | – | – | – |
| | | – | 110 | 2 | 50 ⁽⁹⁾ | 199 | 138 | 205 | 308 | 410 | 250 | 450 | 250 | 600 | 600 | 400 | – | – | – | – |

See page 29 for notes.

400 Volt AC Input Protection Devices – Frames 7...10

| Drive Catalog Number (12) | Frame | kW Rating | | PWM Freq. | Temp. (16) | Input Ratings | | Output Amps | | | Dual Element Time Delay Fuse | | Non-Time Delay Fuse | | Circuit Breaker (3) | Motor Circuit Protector (4) |
|---------------------------|-------|-----------|-----|-----------|------------|---------------|-----|-------------|--------|--------|------------------------------|----------|---------------------|----------|---------------------|-----------------------------|
| | | ND | HD | kHz | °C | Amps | kVA | Cont. | 1 Min. | 3 Sec. | Min. (1) | Max. (2) | Min. (1) | Max. (2) | Max. (8) | Max. (8) |
| 20BC292 | 7 | 160 | – | 4 | 40 | 293 | 203 | 292 | 322 | 438 | 375 | 650 | 375 | 850 | 850 | 400 |
| | | – | 150 | 4 | 40 | 264 | 183 | 263 | 395 | 526 | 350 | 550 | 350 | 550 | 750 | 400 |
| 20BC325 | 7 | 180 | – | 4 | 40 | 326 | 226 | 325 | 358 | 488 | 425 | 700 | 425 | 950 | 950 | 600 |
| | | – | 180 | 4 | 40 | 326 | 226 | 325 | 488 | 650 | 425 | 700 | 425 | 950 | 950 | 600 |
| 20BC365 | 8 | 200 | – | 2 | 40 | 366 | 253 | 365 | 402 | 548 | 475 | 800 | 475 | 1000 | 1000 | 600 |
| | | – | 180 | 2 | 40 | 326 | 226 | 325 | 488 | 650 | 425 | 700 | 425 | 950 | 950 | 600 |
| 20BC415 | 8 | 240 | – | 2 | 40 | 416 | 288 | 415 | 457 | 623 | 525 | 900 | 525 | 1200 | 1200 | 600 |
| | | – | 200 | 2 | 40 | 366 | 253 | 365 | 548 | 730 | 475 | 800 | 475 | 1000 | 1000 | 600 |
| 20BC481 | 8 | 280 | – | 2 | 40 | 483 | 334 | 481 | 530 | 722 | 600 | 1000 | 600 | 1400 | 1400 | 700 |
| | | – | 240 | 2 | 40 | 416 | 288 | 415 | 623 | 830 | 525 | 900 | 525 | 1200 | 1200 | 600 |
| 20BC535 | 8 | 300 | – | 2 | 40 | 537 | 372 | 535 | 589 | 803 | 700 | 1200 | 700 | 1600 | 1600 | 700 |
| | | – | 280 | 2 | 40 | 483 | 334 | 481 | 722 | 962 | 600 | 1000 | 600 | 1400 | 1400 | 700 |
| 20BC600 | 8 | 350 | – | 2 | 40 | 602 | 417 | 600 | 660 | 900 | 750 | 1300 | 750 | 1800 | 1800 | 800 |
| | | – | 300 | 2 | 40 | 537 | 371 | 535 | 803 | 1070 | 700 | 1200 | 700 | 1600 | 1600 | 700 |
| 20BC730 | 9 | 400 | – | 2 | 40 | 702 | 486 | 730 | 803 | 1095 | 900 | 1500 | 900 | 2100 | 2100 | 900 |
| | | – | 350 | 2 | 40 | 602 | 417 | 600 | 900 | 1200 | 750 | 1300 | 750 | 1800 | 1800 | 800 |
| 20BC875 | 10 | 500 | – | 2 | 40 | 877 | 608 | 875 | 963 | 1313 | 1100 | 1900 | 1100 | 2600 | 2600 | 1200 |
| | | – | 400 | 2 | 40 | 877 | 486 | 700 | 1050 | 1400 | 900 | 1500 | 900 | 2100 | 2100 | 900 |

See page 29 for Notes.

480 Volt AC Input Protection Devices – Frames 0...6

| Drive Catalog Number | Frame | Hp Rating | | PWM Freq. | Temp. | Input Ratings | | Output Amps | | | Dual Element Time Delay Fuse | | Non-Time Delay Fuse | | Circuit Breaker (3) | Motor Circuit Protector (4) | 140M Motor Protector with Adjustable Current Range (5)(6) | | | |
|----------------------|-------|-----------|------|-----------|--------------------|---------------|------|-------------|--------|--------|------------------------------|----------|---------------------|----------|---------------------|-----------------------------|---|-----------|---------------------------------|-------|
| | | ND | HD | kHz | °C | Amps | kVA | Cont. | 1 Min. | 3 Sec. | Min. (1) | Max. (2) | Min. (1) | Max. (2) | Max. (8) | Max. (8) | Available Catalog Numbers - 140... (7) | | Min. Enclosure Vol. (in.³) (14) | |
| 20BD1P1 | 0 | 0.5 | 0.33 | 4 | 50 ⁽¹¹⁾ | 0.9 | 0.7 | 1.1 | 1.2 | 1.6 | 3 | 3 | 3 | 6 | 15 | 3 | M-C2E-B16 | – | – | 7269 |
| 20BD2P1 | 0 | 1 | 0.75 | 4 | 50 ⁽¹¹⁾ | 1.6 | 1.4 | 2.1 | 2.4 | 3.2 | 3 | 6 | 3 | 8 | 15 | 3 | M-C2E-B25 | – | – | 7269 |
| 20BD3P4 | 0 | 2 | 1.5 | 4 | 50 ⁽¹¹⁾ | 2.6 | 2.2 | 3.4 | 4.5 | 6 | 4 | 8 | 4 | 12 | 15 | 7 | M-C2E-B40 | M-D8E-B40 | – | 7269 |
| 20BD5P0 | 0 | 3 | 2 | 4 | 50 ⁽¹¹⁾ | 3.9 | 3.2 | 5 | 5.5 | 7.5 | 6 | 10 | 6 | 20 | 20 | 7 | M-C2E-B63 | M-D8E-B63 | – | 7269 |
| 20BD8P0 | 0 | 5 | 3 | 4 | 50 ⁽¹¹⁾ | 6.9 | 5.7 | 8 | 8.8 | 12 | 10 | 15 | 10 | 30 | 30 | 15 | M-C2E-C10 | M-D8E-C10 | M-F8E-C10 | 7269 |
| 20BD011 | 0 | 7.5 | 5 | 4 | 50 ⁽¹¹⁾ | 9.5 | 7.9 | 11 | 12.1 | 16.5 | 15 | 20 | 15 | 40 | 40 | 15 | M-C2E-C16 | M-D8E-C16 | M-F8E-C16 | 7269 |
| 20BD014 | 1 | 10 | 7.5 | 4 | 50 ⁽¹¹⁾ | 12.5 | 10.4 | 14 | 16.5 | 22 | 17.5 | 30 | 17.5 | 50 | 50 | 20 | M-C2E-C16 | M-D8E-C16 | M-F8E-C16 | 7269 |
| 20BD022 | 1 | 15 | 10 | 4 | 50 ⁽¹¹⁾ | 19.9 | 16.6 | 22 | 24.2 | 33 | 25 | 50 | 25 | 80 | 80 | 30 | – | M-D8E-C25 | M-F8E-C25 | 7269 |
| 20BD027 | 2 | 20 | 15 | 4 | 50 ⁽¹¹⁾ | 24.8 | 20.6 | 27 | 33 | 44 | 35 | 60 | 35 | 100 | 100 | 50 | – | – | M-F8E-C32 | 7269 |
| 20BD034 | 2 | 25 | 20 | 4 | 50 ⁽¹¹⁾ | 31.2 | 25.9 | 34 | 40.5 | 54 | 40 | 70 | 40 | 125 | 125 | 50 | – | – | M-F8E-C45 | 7269 |
| 20BD040 | 3 | 30 | 25 | 4 | 50 ⁽¹¹⁾ | 36.7 | 30.5 | 40 | 51 | 68 | 50 | 90 | 50 | 150 | 150 | 50 | – | – | M-F8E-C45 | 13630 |
| 20BD052 | 3 | 40 | 30 | 4 | 50 ⁽¹¹⁾ | 47.7 | 39.7 | 52 | 60 | 80 | 60 | 110 | 60 | 200 | 200 | 70 | – | – | – | – |
| 20BD065 | 3 | 50 | 40 | 4 | 50 ⁽¹¹⁾ | 59.6 | 49.6 | 65 | 78 | 104 | 80 | 125 | 80 | 250 | 250 | 100 | – | – | – | – |
| 20BD077 (12) | 4 | 60 | – | 4 | 50 ⁽¹¹⁾ | 72.3 | 60.1 | 77 | 85 | 116 | 100 | 170 | 100 | 300 | 300 | 100 | – | – | – | – |
| | | – | 50 | 4 | 50 ⁽¹¹⁾ | 59.6 | 49.6 | 65 | 98 | 130 | 80 | 125 | 80 | 250 | 250 | 100 | – | – | – | – |
| 20BD096 (12) | 5 | 75 | – | 4 | 50 ⁽⁹⁾ | 90.1 | 74.9 | 96 | 106 | 144 | 125 | 200 | 125 | 350 | 350 | 125 | – | – | – | – |
| | | – | 60 | 4 | 50 ⁽⁹⁾ | 72.3 | 60.1 | 77 | 116 | 154 | 100 | 170 | 100 | 300 | 300 | 100 | – | – | – | – |
| 20BD125 (12) | 5 | 100 | – | 4 | 50 ⁽⁹⁾ | 117 | 97.6 | 125 | 138 | 163 | 150 | 250 | 150 | 500 | 375 | 150 | – | – | – | – |
| | | – | 75 | 4 | 50 ⁽⁹⁾ | 90.1 | 74.9 | 96 | 144 | 168 | 125 | 200 | 125 | 350 | 350 | 125 | – | – | – | – |
| 20BD156 (12) | 6 | 125 | – | 4 | 50 ⁽⁹⁾ | 147 | 122 | 156 | 172 | 234 | 200 | 350 | 200 | 600 | 450 | 250 | – | – | – | – |
| | | – | 100 | 4 | 50 ⁽⁹⁾ | 131 | 109 | 125 | 188 | 250 | 175 | 250 | 175 | 500 | 375 | 250 | – | – | – | – |
| 20BD180 (12) | 6 | 150 | – | 4 | 50 ⁽⁹⁾ | 169 | 141 | 180 | 198 | 270 | 225 | 400 | 225 | 600 | 500 | 250 | – | – | – | – |
| | | – | 125 | 4 | 50 ⁽⁹⁾ | 147 | 122 | 156 | 234 | 312 | 200 | 350 | 200 | 600 | 450 | 250 | – | – | – | – |
| 20BD248 (12) | 6 | 200 | – | 2 | 45 ⁽⁹⁾ | 233 | 194 | 248 | 273 | 372 | 300 | 550 | 300 | 700 | 700 | 400 | – | – | – | – |
| | | – | 150 | 2 | 50 ⁽⁹⁾ | 169 | 141 | 180 | 270 | 360 | 225 | 400 | 225 | 600 | 500 | 250 | – | – | – | – |

See page 29 for notes.

480 Volt AC Input Protection Devices – Frames 7...10

| Drive Catalog Number (12) | Frame | Hp Rating | | PWM Freq. | Temp. (16) | Input Ratings | | Output Amps | | | Dual Element Time Delay Fuse | | Non-Time Delay Fuse | | Circuit Breaker (3) | Motor Circuit Protector (4) |
|---------------------------|-------|-----------|-----|-----------|------------|---------------|-----|-------------|--------|--------|------------------------------|----------|---------------------|----------|---------------------|-----------------------------|
| | | ND | HD | kHz | °C | Amps | kVA | Cont. | 1 Min. | 3 Sec. | Min. (1) | Max. (2) | Min. (1) | Max. (2) | Max. (8) | Max. (8) |
| 20BD292 | 7 | 250 | | 4 | 40 | 281 | 233 | 292 | 322 | 438 | 375 | 650 | 375 | 850 | 850 | 400 |
| | | | 200 | 4 | 40 | 253 | 210 | 263 | 395 | 526 | 350 | 550 | 350 | 550 | 750 | 400 |
| 20BD325 | 7 | 250 | | 4 | 40 | 313 | 260 | 325 | 358 | 488 | 425 | 700 | 425 | 950 | 950 | 600 |
| | | | 250 | 4 | 40 | 313 | 260 | 325 | 488 | 650 | 425 | 700 | 425 | 950 | 950 | 600 |
| 20BD365 | 8 | 300 | | 2 | 40 | 351 | 292 | 365 | 402 | 548 | 475 | 800 | 475 | 1000 | 1000 | 600 |
| | | | 250 | 2 | 40 | 313 | 260 | 325 | 488 | 650 | 425 | 700 | 425 | 950 | 950 | 600 |
| 20BD415 | 8 | 350 | | 2 | 40 | 399 | 331 | 415 | 457 | 623 | 525 | 900 | 525 | 1200 | 1200 | 600 |
| | | | 300 | 2 | 40 | 351 | 291 | 365 | 548 | 730 | 475 | 800 | 475 | 1000 | 1000 | 600 |
| 20BD481 | 8 | 400 | | 2 | 40 | 462 | 384 | 481 | 530 | 722 | 600 | 1000 | 600 | 1400 | 1400 | 700 |
| | | | 350 | 2 | 40 | 399 | 331 | 415 | 623 | 830 | 525 | 900 | 525 | 1200 | 1200 | 600 |
| 20BD535 | 8 | 450 | | 2 | 40 | 514 | 427 | 535 | 589 | 803 | 700 | 1200 | 700 | 1600 | 1600 | 700 |
| | | | 400 | 2 | 40 | 462 | 384 | 481 | 722 | 962 | 600 | 1000 | 600 | 1400 | 1400 | 700 |
| 20BD600 | 8 | 500 | | 2 | 40 | 577 | 479 | 600 | 660 | 900 | 750 | 1300 | 750 | 1800 | 1800 | 800 |
| | | | 450 | 2 | 40 | 514 | 427 | 535 | 803 | 1070 | 700 | 1200 | 700 | 1600 | 1600 | 700 |
| 20BD730 | 9 | 600 | | 2 | 40 | 673 | 559 | 730 | 803 | 1095 | 900 | 1500 | 900 | 2100 | 2100 | 900 |
| | | | 500 | 2 | 40 | 577 | 479 | 600 | 900 | 1200 | 750 | 1300 | 750 | 1800 | 1800 | 800 |
| 20BD875 | 10 | 700 | | 2 | 40 | 841 | 699 | 875 | 963 | 1313 | 1100 | 1900 | 1100 | 2600 | 2600 | 1200 |
| | | | 600 | 2 | 40 | 673 | 559 | 700 | 1050 | 1400 | 900 | 1500 | 900 | 2100 | 2100 | 900 |

See page 29 for Notes.

600 Volt AC Input Protection Devices – Frames 0...6⁽¹³⁾

| Drive Catalog Number | Frame | Hp Rating | | PWM Freq. kHz | Temp. (11) °C | Input Ratings | | Output Amps | | | Dual Element Time Delay Fuse | | Non-Time Delay Fuse | | Circuit Breaker (3) Max. (8) | Motor Circuit Protector (4) Max. (8) | 140M Motor Protector with Adjustable Current Range (5)(6) | | | Min. Enclosure Vol. (in. 3)(14) |
|----------------------|-------|-----------|-----|---------------|-------------------|---------------|------|-------------|--------|--------|------------------------------|----------|---------------------|----------|------------------------------|--------------------------------------|---|-----------|--|---------------------------------|
| | | ND | HD | | | Amps | kVA | Cont. | 1 Min. | 3 Sec. | Min. (1) | Max. (2) | Min. (1) | Max. (2) | | | Max. (8) | Max. (8) | Available Catalog Numbers - 140... (7) | |
| 20BE1P7 | 0 | 1 | 0.5 | 4 | 50 | 1.3 | 1.4 | 1.7 | 2 | 2.6 | 2 | 4 | 2 | 6 | 15 | 3 | M-C2E-B16 | – | – | 7269 |
| 20BE2P7 | 0 | 2 | 1 | 4 | 50 | 2.1 | 2.1 | 2.7 | 3.6 | 4.8 | 3 | 6 | 3 | 10 | 15 | 3 | M-C2E-B25 | – | – | 7269 |
| 20BE3P9 | 0 | 3 | 2 | 4 | 50 | 3 | 3.1 | 3.9 | 4.3 | 5.9 | 6 | 9 | 6 | 15 | 15 | 7 | M-C2E-B40 | M-D8E-B40 | – | 7269 |
| 20BE6P1 | 0 | 5 | 3 | 4 | 50 | 5.3 | 5.5 | 6.1 | 6.7 | 9.2 | 9 | 12 | 9 | 20 | 20 | 15 | – | M-D8E-B63 | – | 7269 |
| 20BE9P0 | 0 | 7.5 | 5 | 4 | 50 | 7.8 | 8.1 | 9 | 9.9 | 13.5 | 10 | 20 | 10 | 35 | 30 | 15 | – | M-D8E-C10 | M-F8E-C10 | 7269 |
| 20BE011 | 1 | 10 | 7.5 | 4 | 50 | 9.9 | 10.2 | 11 | 13.5 | 18 | 15 | 25 | 15 | 40 | 40 | 15 | – | M-D8E-C10 | M-F8E-C10 | 7269 |
| 20BE017 | 1 | 15 | 10 | 4 | 50 | 15.4 | 16 | 17 | 18.7 | 25.5 | 20 | 40 | 20 | 60 | 50 | 20 | – | M-D8E-C16 | M-F8E-C16 | 7269 |
| 20BE022 | 2 | 20 | 15 | 4 | 50 | 20.2 | 21 | 22 | 25.5 | 34 | 30 | 50 | 30 | 80 | 80 | 30 | – | – | M-F8E-C25 | 7269 |
| 20BE027 | 2 | 25 | 20 | 4 | 50 | 24.8 | 25.7 | 27 | 33 | 44 | 35 | 60 | 35 | 100 | 100 | 50 | – | – | M-F8E-C25 | 7269 |
| 20BE032 | 3 | 30 | 25 | 4 | 50 | 29.4 | 30.5 | 32 | 40.5 | 54 | 40 | 70 | 40 | 125 | 125 | 50 | – | – | M-F8E-C32 | 13630 |
| 20BE041 | 3 | 40 | 30 | 4 | 50 | 37.6 | 39.1 | 41 | 48 | 64 | 50 | 90 | 50 | 150 | 150 | 100 | – | – | – | – |
| 20BE052 | 3 | 50 | 40 | 4 | 50 | 47.7 | 49.6 | 52 | 61.5 | 82 | 60 | 110 | 60 | 200 | 200 | 100 | – | – | – | – |
| 20BE062 | 4 | 60 | 50 | 2 | 50 | 58.2 | 60.5 | 62 | 78 | 104 | 80 | 125 | 80 | 225 | 225 | 100 | – | – | – | – |
| 20BE077 (12) | 5 | 75 | – | 2 | 50 ⁽⁹⁾ | 72.3 | 75.1 | 77 | 85 | 116 | 90 | 150 | 90 | 300 | 300 | 100 | – | – | – | – |
| | | – | 60 | 2 | 50 ⁽⁹⁾ | 58.2 | 60.5 | 63 | 94 | 126 | 90 | 125 | 90 | 250 | 250 | 100 | – | – | – | – |
| 20BE099 (12) | 5 | 100 | – | 2 | 40 ⁽⁹⁾ | 92.9 | 96.6 | 99 | 109 | 126 | 125 | 200 | 125 | 375 | 375 | 150 | – | – | – | – |
| | | – | 75 | 2 | 40 ⁽⁹⁾ | 72.3 | 75.1 | 77 | 116 | 138 | 100 | 175 | 100 | 300 | 300 | 100 | – | – | – | – |
| 20BE125 (12) | 6 | 125 | – | 2 | 50 ⁽⁹⁾ | 117 | 122 | 125 | 138 | 188 | 150 | 250 | 150 | 375 | 375 | 250 | – | – | – | – |
| | | – | 100 | 2 | 50 ⁽⁹⁾ | 93 | 96.6 | 99 | 149 | 198 | 125 | 200 | 125 | 375 | 375 | 150 | – | – | – | – |
| 20BE144 (12) | 6 | 150 | – | 2 | 50 ⁽⁹⁾ | 135 | 141 | 144 | 158 | 216 | 175 | 300 | 175 | 400 | 400 | 250 | – | – | – | – |
| | | – | 125 | 2 | 50 ⁽⁹⁾ | 117 | 122 | 125 | 188 | 250 | 150 | 275 | 150 | 375 | 375 | 250 | – | – | – | – |

See page 29 for notes.

690 Volt AC Input Protection Devices – Frames 0...6⁽¹³⁾

| Drive Catalog Number (12) | Frame | kW Rating | | PWM Freq. kHz | Temp. (11) °C | Input Ratings | | Output Amps | | | Dual Element Time Delay Fuse | | Non-Time Delay Fuse | | Circuit Breaker (3) Max. (8) | Motor Circuit Protector (4) Max. (8) |
|---------------------------|-------|-----------|------|---------------|-------------------|---------------|------|-------------|--------|--------|------------------------------|----------|---------------------|----------|------------------------------|--------------------------------------|
| | | ND | HD | | | Amps | kVA | Cont. | 1 Min. | 3 Sec. | Min. (1) | Max. (2) | Min. (1) | Max. (2) | | |
| 20BF052 | 5 | 45 | – | 4 | 50 ⁽⁹⁾ | 46.9 | 56.1 | 52 | 57 | 78 | 60 | 110 | 60 | 175 | 175 | – |
| | | – | 37.5 | 4 | 50 ⁽⁹⁾ | 40.1 | 48 | 46 | 69 | 92 | 50 | 90 | 50 | 150 | 150 | – |
| 20BF060 | 5 | 55 | – | 4 | 50 ⁽⁹⁾ | 57.7 | 68.9 | 60 | 66 | 90 | 80 | 125 | 80 | 225 | 225 | – |
| | | – | 45 | 4 | 50 ⁽⁹⁾ | 46.9 | 56.1 | 52 | 78 | 104 | 60 | 110 | 60 | 175 | 175 | – |
| 20BF082 | 5 | 75 | – | 2 | 50 ⁽⁹⁾ | 79 | 94.4 | 82 | 90 | 123 | 100 | 200 | 100 | 375 | 375 | – |
| | | – | 55 | 2 | 50 ⁽⁹⁾ | 57.7 | 68.9 | 60 | 90 | 120 | 80 | 125 | 80 | 225 | 225 | – |
| 20BF098 | 5 | 90 | – | 2 | 40 ⁽⁹⁾ | 94.7 | 113 | 98 | 108 | 127 | 125 | 200 | 125 | 375 | 375 | – |
| | | – | 75 | 2 | 40 ⁽⁹⁾ | 79 | 94.4 | 82 | 123 | 140 | 100 | 200 | 100 | 375 | 375 | – |
| 20BF119 | 6 | 110 | – | 2 | 50 ⁽⁹⁾ | 115 | 137 | 119 | 131 | 179 | 150 | 250 | 150 | 400 | – | – |
| | | – | 90 | 2 | 50 ⁽⁹⁾ | 94.7 | 113 | 98 | 147 | 196 | 125 | 200 | 125 | 375 | – | – |
| 20BF142 | 6 | 132 | – | 2 | 50 ⁽⁹⁾ | 138 | 165 | 142 | 156 | 213 | 175 | 300 | 175 | 450 | – | – |
| | | – | 110 | 2 | 50 ⁽⁹⁾ | 115 | 137 | 119 | 179 | 238 | 150 | 250 | 150 | 400 | – | – |

See page 29 for notes.

Notes

- (1) Minimum protection device size is the lowest rated device that supplies maximum protection without nuisance tripping.
- (2) Maximum protection device size is the highest rated device that supplies drive protection. For US NEC, minimum size is 125% of motor FLA. Ratings shown are maximum.
- (3) Circuit Breaker - inverse time breaker. For US NEC, minimum size is 125% of motor FLA. Ratings shown are maximum.
- (4) Motor Circuit Protector - instantaneous trip circuit breaker. For US NEC minimum size is 125% of motor FLA. Ratings shown are maximum.
- (5) Bulletin 140M with adjustable current range must have the current trip set to the minimum range that the device will not trip.
- (6) Manual Self-Protected (Type E) Combination Motor Controller, UL listed for 208 Wye or Delta, 240 Wye or Delta, 480Y/277 or 600Y/347. Not UL listed for use on 480V or 600V Delta/Delta, corner ground, or high-resistance ground systems.
- (7) The AIC ratings of the Bulletin 140M Motor Protector Circuit Breakers can vary. See [Bulletin 140M Motor Protection Circuit Breakers Application Ratings](#).
- (8) Maximum allowable rating by US NEC. Exact size must be chosen for each installation.
- (9) UL Type 12/IP54 (flange mount) heat sink ambient temperature rating is 40° C/ambient of unprotected drive portion (inside enclosure) is 55° C. The ambient temperature for the UL Type 12/IP54 stand-alone drives is 40° C.
- (10) Must remove top label and vent plate, drive enclosure rating is IP00, NEMA/UL Type Open.
- (11) Frames 0...4 temperature rating is for NEMA/UL Type Open. The adhesive top label must be removed to operate drive at this temperature. Frames 5 & 6 do not have a top label.
- (12) Drives have dual current ratings; one for normal duty applications, and one for heavy duty applications. The drive can be operated at either rating.
- (13) Note: 600V class drives below 77 Amps (Frames 0...4) are declared to meet the Low Voltage Directive. It is the responsibility of the user to determine compliance to the EMC directive.
- (14) When using a Manual Self-Protected (Type E) Combination Motor Controller, the drive must be installed in a ventilated or non-ventilated enclosure with the minimum volume specified in this column. Application specific thermal considerations can require a larger enclosure.
- (15) Frame 7...10 drives are CE Certified for use with 400V AC and 480V AC center grounded neutral power supply systems only. It is the responsibility of the user to determine compliance to the EMC directive.
- (16) Temperature rating is for IP20, NEMA/UL Type 1. For IP00, NEMA Type Open the temperature rating is 65° C for the control board and 40° C for the heat sink entry air.

325 Volt DC Input Protection Devices – Frames 0...6

| Drive Catalog Number | Frame | Hp Rating | | PWM Freq. kHz | Temp. (1) °C | DC Input Ratings Amps | Output Amps | | | Fuse | Non-Time Delay Fuse (2)(11) |
|----------------------|-------|-----------|------|---------------|--------------|-----------------------|-------------|--------|--------|------|-----------------------------|
| | | ND | HD | | | | Cont. | 1 Min. | 3 Sec. | | |
| 20BB2P2 | 0 | 0.5 | 0.33 | 4 | 50 | 2 | 2.2 | 2.4 | 3.3 | 5 | JKS-5 |
| 20BB4P2 | 0 | 1 | 0.75 | 4 | 50 | 3.8 | 4.2 | 4.8 | 6.4 | 10 | JKS-10 |
| 20BB6P8 | 1 | 2 | 1.5 | 4 | 50 | 6.9 | 6.8 | 9 | 12 | 15 | HSJ15 |
| 20BB9P6 | 1 | 3 | 2 | 4 | 50 | 9.7 | 9.6 | 10.6 | 14.4 | 20 | HSJ20 |
| 20BB015 | 1 | 5 | 3 | 4 | 50 | 16 | 15.3 | 16.8 | 23 | 30 | HSJ30 |
| 20BB022 | 1 | 7.5 | 5 | 4 | 50 | 23.3 | 22 | 24.2 | 33 | 45 | HSJ45 |
| 20BB028 | 2 | 10 | 7.5 | 4 | 50 | 30 | 28 | 33 | 44 | 60 | HSJ60 |
| 20BB042 | 3 | 15 | 10 | 4 | 50 | 45 | 42 | 46.2 | 63 | 90 | HSJ90 |
| 20BB052 | 3 | 20 | 15 | 4 | 50 | 55 | 52 | 63 | 80 | 100 | HSJ100 |
| 20BB070 | 4 | 25 | 20 | 4 | 50 | 75.3 | 70 | 78 | 105 | 150 | HSJ150 |
| 20BB080 | 4 | 30 | 25 | 4 | 50 | 86.8 | 80 | 105 | 140 | 175 | HSJ175 |
| 20BN104 (3) | 5 | 40 | — | 4 | 50 | 114.1 | 104 | 115 | 175 | 200 | HSJ200 |
| | | — | 30 | 4 | 50 | 85.8 | 80 | 120 | 160 | 200 | HSJ200 |
| 20BN130 (3) | 5 | 50 | — | 4 | 50 | 142.6 | 130 | 143 | 175 | 200 | HSJ200 |
| | | — | 40 | 4 | 50 | 114.1 | 104 | 156 | 175 | 200 | HSJ200 |
| 20BN154 (3) | 6 | 60 | — | 4 | 50 | 169 | 154 | 169 | 231 | 300 | HSJ300 |
| | | — | 50 | 4 | 50 | 142.6 | 130 | 195 | 260 | 300 | HSJ300 |
| 20BN192 (3) | 6 | 75 | — | 4 | 50 | 210.6 | 192 | 211 | 288 | 350 | HSJ350 |
| | | — | 60 | 4 | 50 | 169 | 154 | 231 | 308 | 350 | HSJ350 |
| 20BN260 (3) | 6 | 100 | — | 2 | 45 | 285.3 | 260 | 286 | 390 | 400 | HSJ400 |
| | | — | 75 | 2 | 50 | 210.6 | 205 | 305 | 410 | 400 | HSJ400 |

See [page 32](#) for notes.

540 Volt DC Input Protection Devices – Frames 0...6

| Drive Catalog Number | Frame | kW Rating | | PWM Freq. | Temp. ⁽¹⁾ | DC Input Ratings | | Output Amps | | | Fuse | Non-Time Delay Fuse ⁽²⁾⁽¹¹⁾ |
|---------------------------|-------|-----------|------|-----------|----------------------|------------------|----|-------------|--------|--------|------|--|
| | | ND | HD | kHz | °C | Amps | kW | Cont. | 1 Min. | 3 Sec. | | |
| 20BC1P3 | 0 | 0.37 | 0.25 | 4 | 50 | 1.3 | | 1.3 | 1.4 | 1.9 | 3 | JKS-3 |
| 20BC2P1 | 0 | 0.75 | 0.55 | 4 | 50 | 2.1 | | 2.1 | 2.4 | 3.2 | 6 | JKS-6 |
| 20BC3P5 | 0 | 1.5 | 0.75 | 4 | 50 | 3.7 | | 3.5 | 4.5 | 6 | 8 | JKS-8 |
| 20BC5P0 | 0 | 2.2 | 1.5 | 4 | 50 | 5.3 | | 5 | 5.5 | 7.5 | 10 | JKS-10 |
| 20BC8P7 | 0 | 4 | 3 | 4 | 50 | 9.3 | | 8.7 | 9.9 | 13.2 | 15 | HSJ15 |
| 20BC011 | 0 | 5.5 | 4 | 4 | 50 | 12.6 | | 11.5 | 13 | 17.4 | 20 | HSJ20 |
| 20BC015 | 1 | 7.5 | 5.5 | 4 | 50 | 16.8 | | 15.4 | 17.2 | 23.1 | 25 | HSJ25 |
| 20BC022 | 1 | 11 | 7.5 | 4 | 50 | 24 | | 22 | 24.2 | 33 | 40 | HSJ40 |
| 20BC030 | 2 | 15 | 11 | 4 | 50 | 33.2 | | 30 | 33 | 45 | 50 | HSJ50 |
| 20BC037 | 2 | 18.5 | 15 | 4 | 50 | 40.9 | | 37 | 45 | 60 | 70 | HSJ70 |
| 20BC043 | 3 | 22 | 18.5 | 4 | 50 | 47.5 | | 43 | 56 | 74 | 90 | HSJ90 |
| 20BC056 | 3 | 30 | 22 | 4 | 50 | 61.9 | | 56 | 64 | 86 | 100 | HSJ100 |
| 20BC072 | 3 | 37 | 30 | 4 | 50 ⁽⁷⁾ | 80.5 | | 72 | 84 | 112 | 125 | HSJ125 |
| 20BC085 ⁽³⁾⁽⁵⁾ | 4 | 45 | – | 4 | 45 | 95.1 | | 85 | 94 | 128 | 150 | HSJ150 |
| | | – | 37 | 4 | 45 | 80.5 | | 72 | 108 | 144 | 175 | HSJ175 |
| 20BH105 ⁽³⁾⁽⁵⁾ | 5 | 55 | – | 4 | 50 ⁽⁴⁾ | 120.2 | | 105 | 116 | 158 | 175 | HSJ175 |
| | | – | 45 | 4 | 50 ⁽⁴⁾ | 95.1 | | 85 | 128 | 170 | 200 | HSJ200 |
| 20BH140 ⁽³⁾⁽⁵⁾ | 5 | 75 | – | 4 | 40 ⁽⁴⁾ | 159 | | 140 | 154 | 190 | 225 | HSJ225 |
| | | – | 55 | 4 | 40 ⁽⁴⁾ | 120.2 | | 105 | 158 | 190 | 225 | HSJ225 |
| 20BH170 ⁽³⁾⁽⁵⁾ | 6 | 90 | – | 4 | 50 ⁽⁴⁾ | 192.3 | | 170 | 187 | 255 | 300 | HSJ300 |
| | | – | 75 | 4 | 50 ⁽⁴⁾ | 159 | | 140 | 210 | 280 | 300 | HSJ300 |
| 20BH205 ⁽³⁾⁽⁵⁾ | 6 | 110 | – | 4 | 40 ⁽⁴⁾ | 226 | | 205 | 220 | 289 | 350 | HSJ350 |
| | | – | 90 | 4 | 40 ⁽⁴⁾ | 192.3 | | 170 | 255 | 313 | 350 | HSJ350 |
| 20BH260 ⁽³⁾⁽⁵⁾ | 6 | 132 | – | 2 | 45 ⁽⁴⁾ | 298 | | 260 | 286 | 390 | 500 | HSJ500 |
| | | – | 110 | 2 | 50 ⁽⁴⁾ | 226 | | 205 | 305 | 410 | 500 | HSJ500 |

See [page 32](#) for notes.

540 Volt DC Input with Precharge – Frames 7...10

| Drive Catalog Number | Frame | kW Rating | | PWM Freq. | Temp. | DC Input Ratings | | Output Amps | | | Fuse | Non-Time Delay Fuse ⁽²⁾⁽¹¹⁾ |
|-------------------------|-------|-----------|-----|-----------|-------|------------------|-----|-------------|--------|--------|---------------------|--|
| | | ND | HD | kHz | °C | Amps | kW | Cont. | 1 Min. | 3 Sec. | | |
| 20BP292 | 7 | 160 | | 4 | 40 | 342 | 185 | 292 | 322 | 438 | 500 | 170M6608 ⁽¹⁰⁾ |
| | | | 150 | 4 | 40 | 309 | 166 | 263 | 395 | 526 | 630 | 170M6610 ⁽¹⁰⁾ |
| 20BP325 | 7 | 180 | | 4 | 40 | 381 | 206 | 325 | 358 | 488 | 630 | 170M6610 ⁽¹⁰⁾ |
| | | | 180 | 4 | 40 | 381 | 206 | 325 | 488 | 650 | 800 | 170M6612 ⁽¹⁰⁾ |
| 20BP365 | 8 | 200 | | 2 | 40 | 428 | 231 | 365 | 402 | 548 | 630 | 170M6610 ⁽¹⁰⁾ |
| | | | 180 | 2 | 40 | 381 | 206 | 325 | 488 | 650 | 800 | 170M6612 ⁽¹⁰⁾ |
| 20BP415 | 8 | 240 | | 2 | 40 | 487 | 262 | 415 | 457 | 623 | 800 | 170M6612 ⁽¹⁰⁾ |
| | | | 200 | 2 | 40 | 428 | 231 | 365 | 548 | 730 | 900 | 170M6613 ⁽¹⁰⁾ |
| 20BP481 | 8 | 280 | | 2 | 40 | 564 | 304 | 481 | 530 | 722 | 900 | 170M6613 ⁽¹⁰⁾ |
| | | | 240 | 2 | 40 | 487 | 262 | 415 | 623 | 830 | 1000 | 170M6614 ⁽¹⁰⁾ |
| 20BP535 | 8 | 300 | | 2 | 40 | 627 | 338 | 535 | 589 | 803 | 1000 | 170M6614 ⁽¹⁰⁾ |
| | | | 280 | 2 | 40 | 564 | 304 | 481 | 722 | 962 | 1100 | 170M6615 ⁽¹⁰⁾ |
| 20BP600 | 8 | 350 | | 2 | 40 | 703 | 379 | 600 | 660 | 900 | 1100 ⁽⁸⁾ | 170M6615 ⁽¹⁰⁾ |
| | | | 300 | 2 | 40 | 627 | 338 | 535 | 803 | 1070 | 1200 ⁽⁸⁾ | 170M6616 ⁽¹⁰⁾ |
| 20BP730 | 9 | 400 | | 2 | 40 | 855 | 461 | 730 | 803 | 1095 | 1200 ⁽⁹⁾ | 170M6616 ⁽¹⁰⁾ |
| | | | 350 | 2 | 40 | 703 | 379 | 600 | 900 | 1200 | 1400 ⁽⁹⁾ | 170M6617 ⁽¹⁰⁾ |
| 20BH875 No Precharge | 10 | 500 | | 2 | 40 | 1025 | 553 | 875 | 963 | 1313 | 2 x 800 | 170M6612 ⁽¹⁰⁾ |
| | | | 400 | 2 | 40 | 820 | 443 | 700 | 1050 | 1400 | 2 x 800 | 170M6612 ⁽¹⁰⁾ |

See [page 32](#) for notes.

650 Volt DC Input Protection Devices – Frames 0...6

| Drive Catalog Number | Frame | Hp Rating | | PWM Freq. kHz | Temp. ⁽¹⁾ °C | DC Input Ratings | | Output Amps | | | Fuse | Non-Time Delay Fuse ⁽²⁾⁽¹¹⁾ |
|---------------------------|-------|-----------|------|---------------|-------------------------|------------------|----|-------------|--------|--------|------|--|
| | | ND | HD | | | Amps | kW | Cont. | 1 Min. | 3 Sec. | | |
| 20BD1P1 | 0 | 0.5 | 0.33 | 4 | 50 | 1.0 | | 1.1 | 1.2 | 1.6 | 3 | JKS-3 |
| 20BD2P1 | 0 | 1 | 0.75 | 4 | 50 | 1.9 | | 2.1 | 2.4 | 3.2 | 6 | JKS-6 |
| 20BD3P4 | 0 | 2 | 1.5 | 4 | 50 | 3.0 | | 3.4 | 4.5 | 6.0 | 6 | JKS-6 |
| 20BD5P0 | 0 | 3 | 2 | 4 | 50 | 4.5 | | 5.0 | 5.5 | 7.5 | 10 | JKS-10 |
| 20BD8P0 | 0 | 5 | 3 | 4 | 50 | 8.1 | | 8.0 | 8.8 | 12 | 15 | HSJ15 |
| 20BD011 | 0 | 7.5 | 5 | 4 | 50 | 11.1 | | 11 | 12.1 | 16.5 | 20 | HSJ20 |
| 20BD014 | 1 | 10 | 7.5 | 4 | 50 | 14.7 | | 14 | 16.5 | 22 | 30 | HSJ30 |
| 20BD022 | 1 | 15 | 10 | 4 | 50 | 23.3 | | 22 | 24.2 | 33 | 40 | HSJ40 |
| 20BD027 | 2 | 20 | 15 | 4 | 50 | 28.9 | | 27 | 33 | 44 | 50 | HSJ50 |
| 20BD034 | 2 | 25 | 20 | 4 | 50 | 36.4 | | 34 | 40.5 | 54 | 60 | HSJ60 |
| 20BD040 | 3 | 30 | 25 | 4 | 50 | 42.9 | | 40 | 51 | 68 | 80 | HSJ80 |
| 20BD052 | 3 | 40 | 30 | 4 | 50 | 55.7 | | 52 | 60 | 80 | 90 | HSJ90 |
| 20BD065 | 3 | 50 | 40 | 4 | 50 | 69.7 | | 65 | 78 | 104 | 100 | HSJ100 |
| 20BD077 ⁽³⁾ | 4 | 60 | – | 4 | 50 | 84.5 | | 77 | 85 | 116 | 150 | HSJ150 |
| | | – | 50 | 4 | 50 | 69.7 | | 65 | 98 | 130 | 150 | HSJ150 |
| 20BR096 ⁽³⁾⁽⁶⁾ | 5 | 75 | – | 4 | 50 ⁽⁴⁾ | 105.3 | | 96 | 106 | 144 | 175 | HSJ175 |
| | | – | 60 | 4 | 50 ⁽⁴⁾ | 84.5 | | 77 | 116 | 154 | 175 | HSJ175 |
| 20BR125 ⁽³⁾⁽⁶⁾ | 5 | 100 | – | 4 | 50 ⁽⁴⁾ | 137.1 | | 125 | 138 | 163 | 200 | HSJ200 |
| | | – | 75 | 4 | 50 ⁽⁴⁾ | 105.3 | | 96 | 144 | 168 | 200 | HSJ200 |
| 20BR156 ⁽³⁾⁽⁶⁾ | 6 | 125 | – | 4 | 50 ⁽⁴⁾ | 171.2 | | 156 | 172 | 234 | 300 | HSJ300 |
| | | – | 100 | 4 | 50 ⁽⁴⁾ | 137.1 | | 125 | 188 | 250 | 300 | HSJ300 |
| 20BR180 ⁽³⁾⁽⁶⁾ | 6 | 150 | – | 4 | 50 ⁽⁴⁾ | 204 | | 180 | 198 | 270 | 400 | HSJ400 |
| | | – | 125 | 4 | 50 ⁽⁴⁾ | 171.2 | | 156 | 234 | 312 | 400 | HSJ400 |
| 20BR248 ⁽³⁾⁽⁶⁾ | 6 | 200 | – | 2 | 45 ⁽⁴⁾ | 272 | | 248 | 273 | 372 | 400 | HSJ400 |
| | | – | 150 | 2 | 50 ⁽⁴⁾ | 204 | | 180 | 270 | 360 | 400 | HSJ400 |

See [page 32](#) for notes.

650 Volt DC Input with Precharge – Frames 7...10

| Drive Catalog Number | Frame | Hp Rating | | PWM Freq. kHz | Temp. °C | DC Input Ratings | | Output Amps | | | Fuse | Non-Time Delay Fuse ⁽²⁾⁽¹¹⁾ |
|-------------------------|-------|-----------|-----|---------------|----------|------------------|-----|-------------|--------|--------|---------------------|--|
| | | ND | HD | | | Amps | kW | Cont. | 1 Min. | 3 Sec. | | |
| 20BR292 | 7 | 250 | | 4 | 40 | 328 | 212 | 292 | 322 | 438 | 500 | 170M6608 ⁽¹⁰⁾ |
| | | | 200 | 4 | 40 | 296 | 191 | 263 | 395 | 526 | 630 | 170M6610 ⁽¹⁰⁾ |
| 20BR325 | 7 | 250 | | 4 | 40 | 365 | 236 | 325 | 358 | 488 | 550 | 170M6609 ⁽¹⁰⁾ |
| | | | 250 | 4 | 40 | 365 | 236 | 325 | 488 | 650 | 800 | 170M6612 ⁽¹⁰⁾ |
| 20BR365 | 8 | 300 | | 2 | 40 | 410 | 265 | 365 | 402 | 548 | 630 | 170M6610 ⁽¹⁰⁾ |
| | | | 250 | 2 | 40 | 365 | 236 | 325 | 488 | 650 | 800 | 170M6612 ⁽¹⁰⁾ |
| 20BR415 | 8 | 350 | | 2 | 40 | 466 | 302 | 415 | 457 | 623 | 700 | 170M6611 ⁽¹⁰⁾ |
| | | | 300 | 2 | 40 | 410 | 265 | 365 | 548 | 730 | 800 | 170M6612 ⁽¹⁰⁾ |
| 20BR481 | 8 | 400 | | 2 | 40 | 540 | 350 | 481 | 530 | 722 | 800 | 170M6619 ⁽¹⁰⁾ |
| | | | 350 | 2 | 40 | 466 | 302 | 415 | 623 | 830 | 900 | 170M6613 ⁽¹⁰⁾ |
| 20BR535 | 8 | 450 | | 2 | 40 | 601 | 389 | 535 | 589 | 803 | 900 | 170M6613 ⁽¹⁰⁾ |
| | | | 400 | 2 | 40 | 540 | 350 | 481 | 722 | 962 | 1000 | 170M6614 ⁽¹⁰⁾ |
| 20BR600 | 8 | 500 | | 2 | 40 | 674 | 436 | 600 | 660 | 900 | 1000 ⁽⁸⁾ | 170M6614 ⁽¹⁰⁾ |
| | | | 450 | 2 | 40 | 601 | 389 | 535 | 803 | 1070 | 1200 ⁽⁸⁾ | 170M6616 ⁽¹⁰⁾ |
| 20BR730 | 9 | 600 | | 2 | 40 | 820 | 533 | 730 | 803 | 1095 | 1200 ⁽⁹⁾ | 170M6616 ⁽¹⁰⁾ |
| | | | 500 | 2 | 40 | 674 | 436 | 600 | 900 | 1200 | 1400 ⁽⁹⁾ | 170M6617 ⁽¹⁰⁾ |
| 20BJ875 No Precharge | 10 | 700 | | 2 | 40 | 983 | 636 | 875 | 963 | 1313 | 1400 | 2 x 170M6611 ⁽¹⁰⁾ |
| | | | 600 | 2 | 40 | 786 | 509 | 700 | 1050 | 1400 | 1600 | 2 x 170M6612 ⁽¹⁰⁾ |

See [page 32](#) for notes.

810 Volt DC Input Protection Devices – Frames 0...6

| Drive Catalog Number | Frame | Hp Rating | | PWM Freq. kHz | Temp. ⁽¹⁾ °C | DC Input Ratings Amps | Output Amps | | | Fuse | Non-Time Delay Fuse ⁽²⁾⁽¹¹⁾ |
|------------------------|-------|-----------|------|---------------|-------------------------|-----------------------|-------------|--------|--------|------|--|
| | | ND | HD | | | | Cont. | 1 Min. | 3 Sec. | | |
| 20BE1P7 | 0 | 1 | 0.75 | 4 | 50 | 1.5 | 1.7 | 2 | 2.6 | 3 | JKS-3 |
| 20BE2P7 | 0 | 2 | 1.5 | 4 | 50 | 2.4 | 2.7 | 3.6 | 4.8 | 6 | JKS-6 |
| 20BE3P9 | 0 | 3 | 2 | 4 | 50 | 3.5 | 3.9 | 4.3 | 5.9 | 6 | JKS-6 |
| 20BE6P1 | 0 | 5 | 3 | 4 | 50 | 6.2 | 6.1 | 6.7 | 9.2 | 10 | JKS-10 |
| 20BE9P0 | 0 | 7.5 | 5 | 4 | 50 | 9.1 | 9 | 9.9 | 13.5 | 15 | HSJ15 |
| 20BE011 | 0 | 10 | 7.5 | 4 | 50 | 11.5 | 11 | 13.5 | 18 | 20 | HSJ20 |
| 20BE017 | 1 | 15 | 10 | 4 | 50 | 18 | 17 | 18.7 | 25.5 | 30 | HSJ30 |
| 20BE022 | 2 | 20 | 15 | 4 | 50 | 23.6 | 22 | 25.5 | 34 | 40 | HSJ40 |
| 20BE027 | 2 | 25 | 20 | 4 | 50 | 29 | 27 | 33 | 44 | 50 | HSJ50 |
| 20BE032 | 3 | 30 | 25 | 4 | 50 | 34.3 | 32 | 40.5 | 54 | 60 | HSJ60 |
| 20BE041 | 3 | 40 | 30 | 4 | 50 | 43.9 | 41 | 48 | 64 | 70 | HSJ70 |
| 20BE052 | 3 | 50 | 40 | 4 | 50 | 55.7 | 52 | 61.5 | 82 | 90 | HSJ90 |
| 20BE062 | 4 | 60 | 50 | 2 | 50 | 68 | 62 | 78 | 104 | 125 | HSJ125 |
| 20BT099 ⁽³⁾ | 5 | 100 | – | 2 | 40 | 108.6 | 99 | 109 | 126 | 150 | HSJ150 |
| | | – | 75 | 2 | 40 | 84.5 | 77 | 116 | 138 | 150 | HSJ150 |
| 20BT144 ⁽³⁾ | 6 | 150 | – | 2 | 50 | 158 | 144 | 158 | 216 | 250 | HSJ250 |
| | | – | 125 | 2 | 50 | 137.1 | 125 | 188 | 250 | 250 | HSJ250 |

932 Volt DC Input Protection Devices – Frames 0...6

| Drive Catalog Number | Frame | kW Rating | | PWM Freq. kHz | Temp. ⁽¹⁾ °C | DC Input Ratings Amps | Output Amps | | | Fuse | Non-Time Delay Fuse ⁽²⁾⁽¹¹⁾ |
|------------------------|-------|-----------|------|---------------|-------------------------|-----------------------|-------------|--------|--------|------|--|
| | | ND | HD | | | | Cont. | 1 Min. | 3 Sec. | | |
| 20BW052 ⁽³⁾ | 5 | 45 | – | 2 | 50 ⁽⁴⁾ | 58.2 | 52 | 57 | 78 | 100 | 170M3691 |
| | | – | 37.5 | 2 | 50 ⁽⁴⁾ | 46.9 | 46 | 69 | 92 | 100 | 170M3691 |
| 20BW098 ⁽³⁾ | 5 | 90 | – | 2 | 50 ⁽⁴⁾ | 110.7 | 98 | 108 | 127 | 160 | 170M3693 |
| | | – | 75 | 2 | 50 ⁽⁴⁾ | 92.3 | 82 | 123 | 140 | 160 | 170M3693 |
| 20BW142 ⁽³⁾ | 6 | 132 | – | 2 | 50 ⁽⁴⁾ | 162.2 | 142 | 156 | 213 | 250 | 170M3695 |
| | | – | 110 | 2 | 40 ⁽⁴⁾ | 134.9 | 119 | 179 | 238 | 315 | 170M3696 |

Notes

- ⁽¹⁾ Frames 0...4 temperature rating is for NEMA/UL Type Open. The adhesive top label must be removed to operate drive at this temperature. Frames 5 & 6 do not have a top label.
- ⁽²⁾ The power source to common bus inverters must be derived from AC voltages 600V or less, as defined in NFPA70; Art 430-18 (NEC). Battery supplies or MG sets are not included. The following devices were validated to break current of the derived power DC Bus.
Disconnects: Allen-Bradley Bulletin 1494, 30-400A; 194, 30-400A; or ABB OESA, 600 & 800A; OESL, all sizes.
Fuses: Bussmann Type JKS, all sizes; Type 170M, Case Sizes 1, 2 and 3, or Ferraz Shawmut Type HSJ, all sizes. For any other devices, please contact the factory.
- ⁽³⁾ Drives have dual current ratings; one for normal duty applications, and one for heavy duty applications. The drive can be operated at either rating.
- ⁽⁴⁾ UL Type 12/IP54 (flange mount) heatsink ambient temperature rating is 40 °C/ambient of unprotected drive portion (inside enclosure) is 55 °C. The ambient temperature for the UL Type 12/IP54 stand-alone drives is 40 °C.
- ⁽⁵⁾ Also applies to "P" voltage class.
- ⁽⁶⁾ Also applies to "J" voltage class.
- ⁽⁷⁾ Must remove top label and vent plate, drive enclosure rating is IP00, NEMA/UL Type Open.
- ⁽⁸⁾ Two 630A Bussmann 170M6608 can also be used.
- ⁽⁹⁾ Two 700A Bussmann 170M6611 can also be used.
- ⁽¹⁰⁾ Bussmann or equivalent.
- ⁽¹¹⁾ See Fuse Certification and Test Data in PowerFlex AC Drives in Common Bus Configurations Application Guidelines, publication [DRIVES-AT002](#), for fuse self-certification and test data for Bussmann 170M and JKS fuses recommended for the DC bus fusing.

Cable Recommendations

Power Cable Types Acceptable for 200...600 Volt Installations

A variety of cable types are acceptable for drive installations. For many installations, unshielded cable is adequate, provided it can be separated from sensitive circuits. As an approximate guide, allow a spacing of 0.3 meters (1 foot) for every 10 meters (32.8 feet) of length. In all cases, long parallel runs must be avoided. Do not use cable with an insulation thickness less than or equal to 15 mils (0.4mm/0.015 in.). Use Copper wire only. Wire gauge requirements and recommendations are based on 75° C. Do not reduce wire gauge when using higher temperature wire. See table below.

| Location | Rating/Type | Description |
|----------------------------------|---|---|
| Standard (Option 1) | 600V, 90° C (194° F) XHHW2/RHW-2 Anixter B209500-B209507, Belden 29501-29507, or equivalent | <ul style="list-style-type: none"> Four tinned copper conductors with XLP insulation. Copper braid/aluminum foil combination shield and tinned copper drain wire. PVC jacket. |
| Standard (Option 2) | Tray rated 600V, 90° C (194° F) RHH/RHW-2 Anixter OLF-7xxxxx or equivalent | <ul style="list-style-type: none"> Three tinned copper conductors with XLPE insulation. 5 mil single helical copper tape (25% overlap min.) with three bare copper grounds in contact with shield. PVC jacket. |
| Class I & II; Division I & II | Tray rated 600V, 90° C (194° F) RHH/RHW-2 Anixter 7V-7xxx-3G or equivalent | <ul style="list-style-type: none"> Three bare copper conductors with XLPE insulation and impervious corrugated continuously welded aluminum armor. Black sunlight resistant PVC jacket overall. Three copper grounds on #10 AWG and smaller. |

Unshielded

THHN, THWN or similar wire is acceptable for drive installation in dry environments provided adequate free air space and/or conduit fill rates limits are provided. **Do not use THHN or similarly coated wire in wet areas.** Any wire chosen must have a minimum insulation thickness of 15 Mil and should not have large variations in insulation concentricity.

Shielded/Armored Cable

Shielded cable contains all of the general benefits of multi-conductor cable with the added benefit of a copper braided shield that can contain much of the noise generated by a typical AC drive. Strong consideration for shielded cable should be given in installations with sensitive equipment such as weigh scales, capacitive proximity switches and other devices that may be affected by electrical noise in the distribution system. Applications with large numbers of drives in a similar location, imposed EMC regulations or a high degree of communications/ networking are also good candidates for shielded cable.

Shielded cable may also help reduce shaft voltage and induced bearing currents for some applications. In addition, the increased impedance of shielded cable may help extend the distance that the motor can be located from the drive without the addition of motor protective devices such as terminator networks.

Consideration should be given to all of the general specifications dictated by the environment of the installation, including temperature, flexibility, moisture characteristics and chemical resistance. In addition, a braided shield should be included and be specified by the cable manufacturer as having coverage of at least 75%. An additional foil shield can greatly improve noise containment.

A good example of recommended cable is Belden® 295xx (xx determines gauge). This cable has four (4) XLPE insulated conductors with a 100% coverage foil and an 85% coverage copper braided shield (with drain wire) surrounded by a PVC jacket.

Other types of shielded cable are available, but the selection of these types may limit the allowable cable length. Particularly, some of the newer cables twist 4 conductors of THHN wire and wrap them tightly with a foil shield. This construction can greatly increase the cable charging current required and reduce the overall drive performance. Unless specified in the individual distance tables as tested with the drive, these cables are not recommended and their performance against the lead length limits supplied is not known.

Maximum Motor Cable Lengths

For information on maximum motor cable lengths, refer to the Wiring and Grounding Guidelines for Pulse Width Modulated (PWM) AC Drives, publication [DRIVES-IN001](#).

Power Wiring

The PowerFlex 700 has the following built in protective features to help simplify installation:

- Ground fault protection during start up and running ensures reliable operation
- Electronic motor overload protection increases motor life
- Removable MOV to ground and common mode capacitors to ground ensure compatibility with ungrounded systems. These devices must be disconnected if the drive is installed on a resistive grounded distribution system, an ungrounded distribution system, a B phase grounded distribution system or impedance grounded system. These devices must also be disconnected if the drive power source is a regenerative unit (such as a bus supply and brake) or is DC fed from an active converter.
- 6 kV transient protection provides increased robustness for 380...480V system voltages

There are many other factors that must be considered for optimal performance in any given application. The block diagram below highlights the primary installation considerations. Consult the Wiring and Grounding Guidelines for Pulse Width Modulated (PWM) AC Drives, publication [DRIVES-IN001](#) for detailed recommendations on input power conditioning, dynamic braking, reflected wave protection and motor cable types.

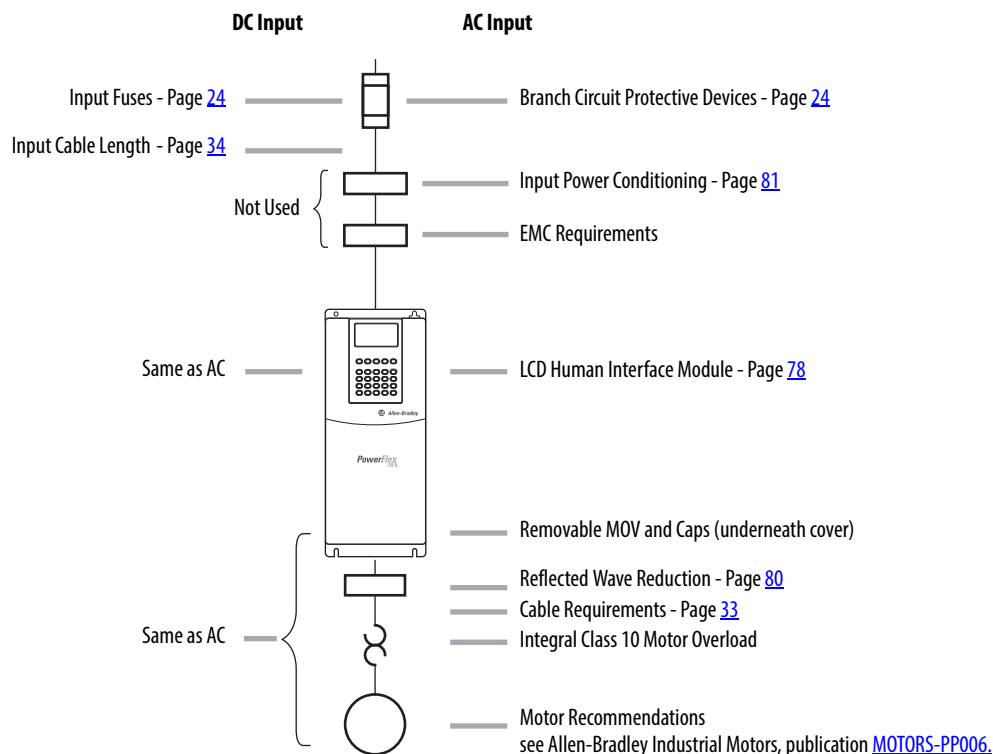

Terminal Blocks

Terminal Block Specifications

Refer to pages 36...38 for typical locations.

| No. | Name | Frame | Description | Wire Size Range - See Note ⁽³⁾ | | Torque | |
|-------|--|--|---|--|--------------------------------|-------------------------|-----------------------|
| | | | | Maximum | Minimum | Maximum | Recommended |
| ① | Power Terminal Block | 0 & 1 | Input power and motor connections | 4.0 mm ² (12 AWG) | 0.5 mm ² (22 AWG) | 1.7 N•m (15 lb.-in.) | 0.8 N•m (7 lb.-in.) |
| | | 2 | Input power and motor connections | 10.0 mm ² (8 AWG) | 0.8 mm ² (18 AWG) | 1.7 N•m (15 lb.-in.) | 1.4 N•m (12 lb.-in.) |
| | | 3 | Input power and motor connections | 25.0 mm ² (3 AWG) | 2.5 mm ² (14 AWG) | 3.6 N•m (32 lb.-in.) | 1.8 N•m (16 lb.-in.) |
| | | | BR1, 2 terminals | 10.0 mm ² (8 AWG) | 0.8 mm ² (18 AWG) | 1.7 N•m (15 lb.-in.) | 1.4 N•m (12 lb.-in.) |
| | | 4 | Input power and motor connections | 35.0 mm ² (2 AWG) | 10.0 mm ² (8 AWG) | 4.0 N•m (35 lb.-in.) | 4.0 N•m (35 lb.-in.) |
| | | 5 75 Hp, 480V 100 Hp, 600V | Input power, DC+, DC-, BR1, 2, PE, motor connections | 50.0 mm ² (1/0 AWG) | 4.0 mm ² (12 AWG) | See Note ⁽⁵⁾ | |
| | | 5 100 Hp | Input power, DC+, DC- and motor | 70.0 mm ² (2/0 AWG) | 10.0 mm ² (8 AWG) | | |
| | | | BR1, 2, PE terminals | 50.0 mm ² (1/0 AWG) | 4.0 mm ² (12 AWG) | | |
| | | 6 | Input power, DC+, DC-, BR1, 2, PE, motor connections | 150.0 mm ² (300 MCM) see Note ⁽⁴⁾ | 2.5 mm ² (14 AWG) | 6.0 N•m (52 lb.-in.) | 6.0 N•m (52 lb.-in.) |
| | | 7 | Input power, DC+, DC-, PE, motor connections | 150.0 mm ² (300 MCM) see Note ⁽⁴⁾ | 2.5 mm ² (14 AWG) | 2.7 N•m (24 lb.-in.) | 2.7 N•m (24 lb.-in.) |
| 8 & 9 | Input power, DC+, DC-, PE, motor connections | 300.0 mm ² (600 MCM) see Note ⁽⁴⁾ | 2.5 mm ² (14 AWG) | 10.0 N•m (87 lb.-in.) | 10.0 N•m (87 lb.-in.) | | |
| 10 | Input power, DC+, DC-, PE, motor connections | 300.0 mm ² (600 MCM) see Note ⁽⁴⁾ | 2.5 mm ² (14 AWG) | 10.0 N•m (87 lb.-in.) | 10.0 N•m (87 lb.-in.) | | |
| ② | SHLD Terminal | 0...6 | Terminating point for wiring shields | — | — | 1.6 N•m (14 lb.-in.) | 1.6 N•m (14 lb.-in.) |
| ③ | AUX Terminal Block | 0...4 | Auxiliary control voltage PS+, PS- ⁽¹⁾⁽²⁾ | 1.5 mm ² (16 AWG) | 0.2 mm ² (24 AWG) | — | — |
| | | 5...6 | | 4.0 mm ² (12 AWG) | 0.5 mm ² (22 AWG) | 0.6 N•m (5.3 lb.-in.) | 0.6 N•m (5.3 lb.-in.) |
| | | 7...10 | | 4.0 mm ² (12 AWG) | 0.049 mm ² (30 AWG) | 0.6 N•m (5.3 lb.-in.) | 0.6 N•m (5.3 lb.-in.) |
| ④ | I/O Terminal Block | 0...6 | Signal & control connections | 2.5 mm ² (14 AWG) | 0.30 mm ² (22 AWG) | 0.6 N•m (5.3 lb.-in.) | 0.6 N•m (5.3 lb.-in.) |
| | | 7...10 | | 4.0 mm ² (12 AWG) | 0.049 mm ² (30 AWG) | 0.6 N•m (5.3 lb.-in.) | 0.6 N•m (5.3 lb.-in.) |
| ⑤ | Encoder Terminal Block | 0...10 | Encoder power & signal connections | 0.75 mm ² (18 AWG) | 0.196 mm ² (24 AWG) | 0.6 N•m (5.3 lb.-in.) | 0.6 N•m (5.3 lb.-in.) |
| ⑥ | Fan Terminal Block | 5...6 | User supplied fan voltage | 4.0 mm ² (12 AWG) | 0.5 mm ² (22 AWG) | 0.6 N•m (5.3 lb.-in.) | 0.6 N•m (5.3 lb.-in.) |
| | | 7 | | 4.0 mm ² (12 AWG) | 0.5 mm ² (22 AWG) | 0.9 N•m (8.0 lb.-in.) | 0.6 N•m (5.3 lb.-in.) |
| | | 8...10 | | 4.0 mm ² (12 AWG) | 0.5 mm ² (22 AWG) | 0.6 N•m (5.3 lb.-in.) | 0.6 N•m (5.3 lb.-in.) |

(1) External control power: UL Installation-300V DC, ±10%, Non UL Installation-270...600V DC, ±10% (0...3 Frame-40W, 165 mA, 5 Frame-80W, 90 mA).

(2) An Auxiliary Control Power Supply such as the 20-24V-AUX can be used with 400/480 and 600/690 Volt drives with Vector Control. However, consult the factory before using an auxiliary power supply in these instances. **Important:** The Auxiliary Control Power Supply **Must Not** be used with any Standard Control drive or any 200/240V PowerFlex 700 drive, Standard or Vector Control.

(3) **Maximum/minimum sizes that the terminal block will accept - these are not recommendations.**

(4) If may be necessary to connect multiple wires in parallel to these terminals using multiple lugs.

(5) Refer to the terminal block label inside the drive.

Typical Terminal Block Location

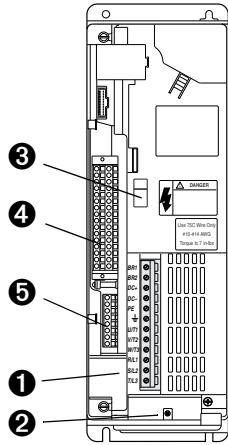

Frames 0...1

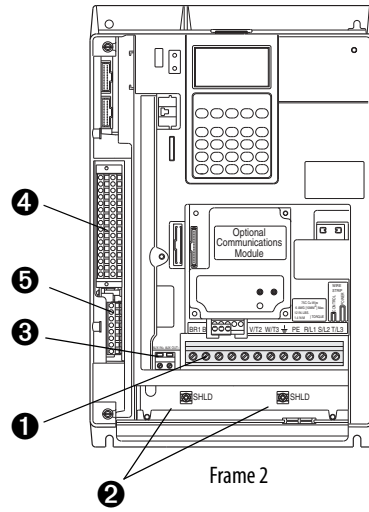

Frame 2

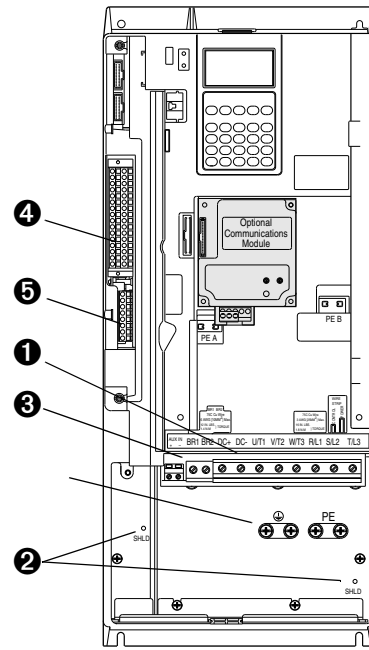

Frames 3...4

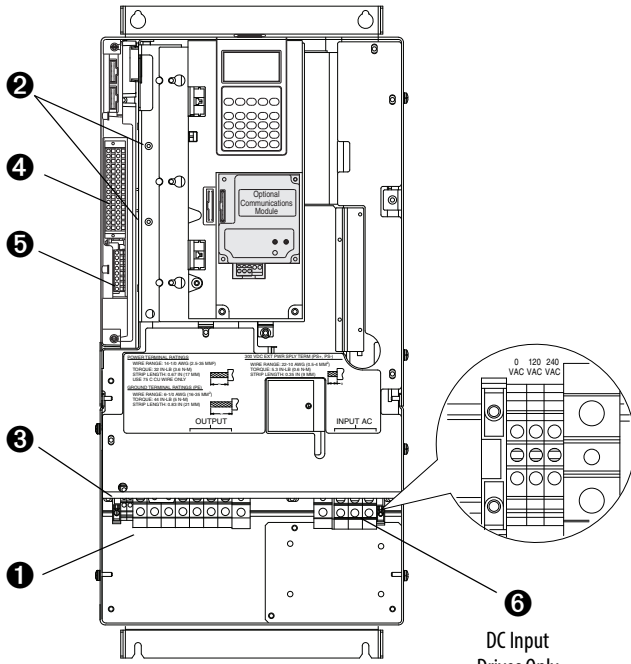

Frame 5

DC Input Drives Only

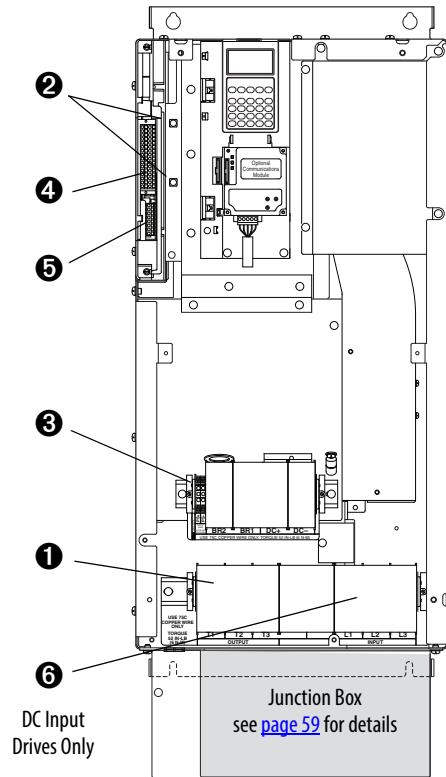

Frame 6

DC Input Drives Only

⊕ / PE

Typical Terminal Block Locations (continued)

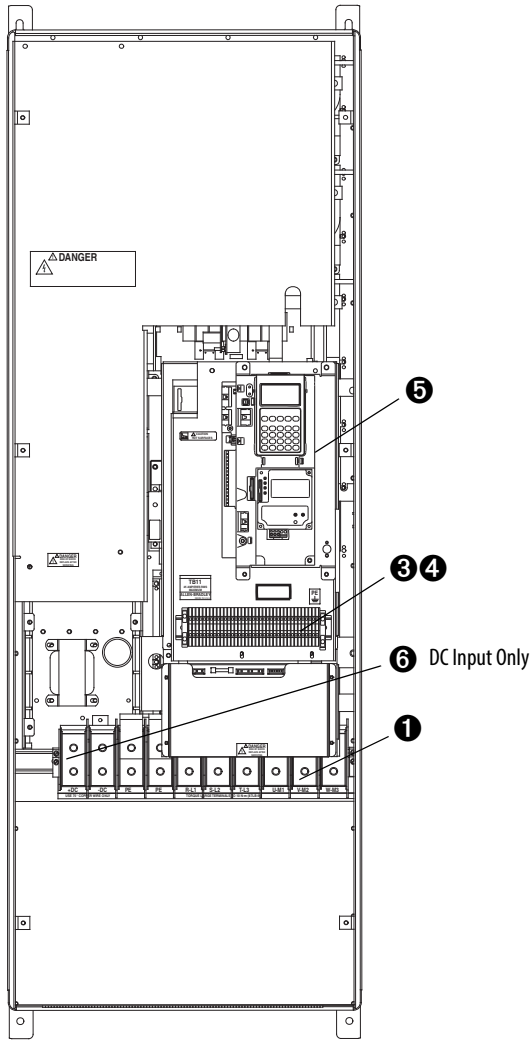

Frame 7

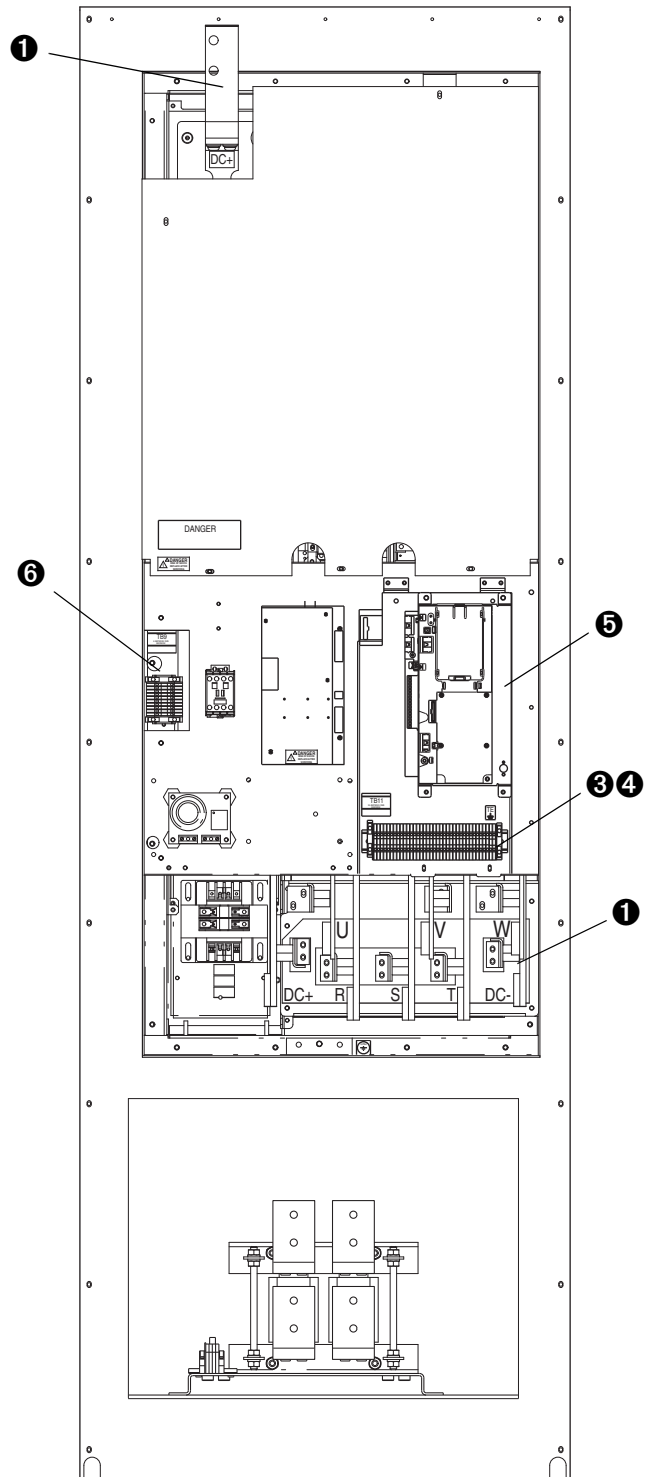

Frames 8...9

Typical Terminal Block Locations (continued)

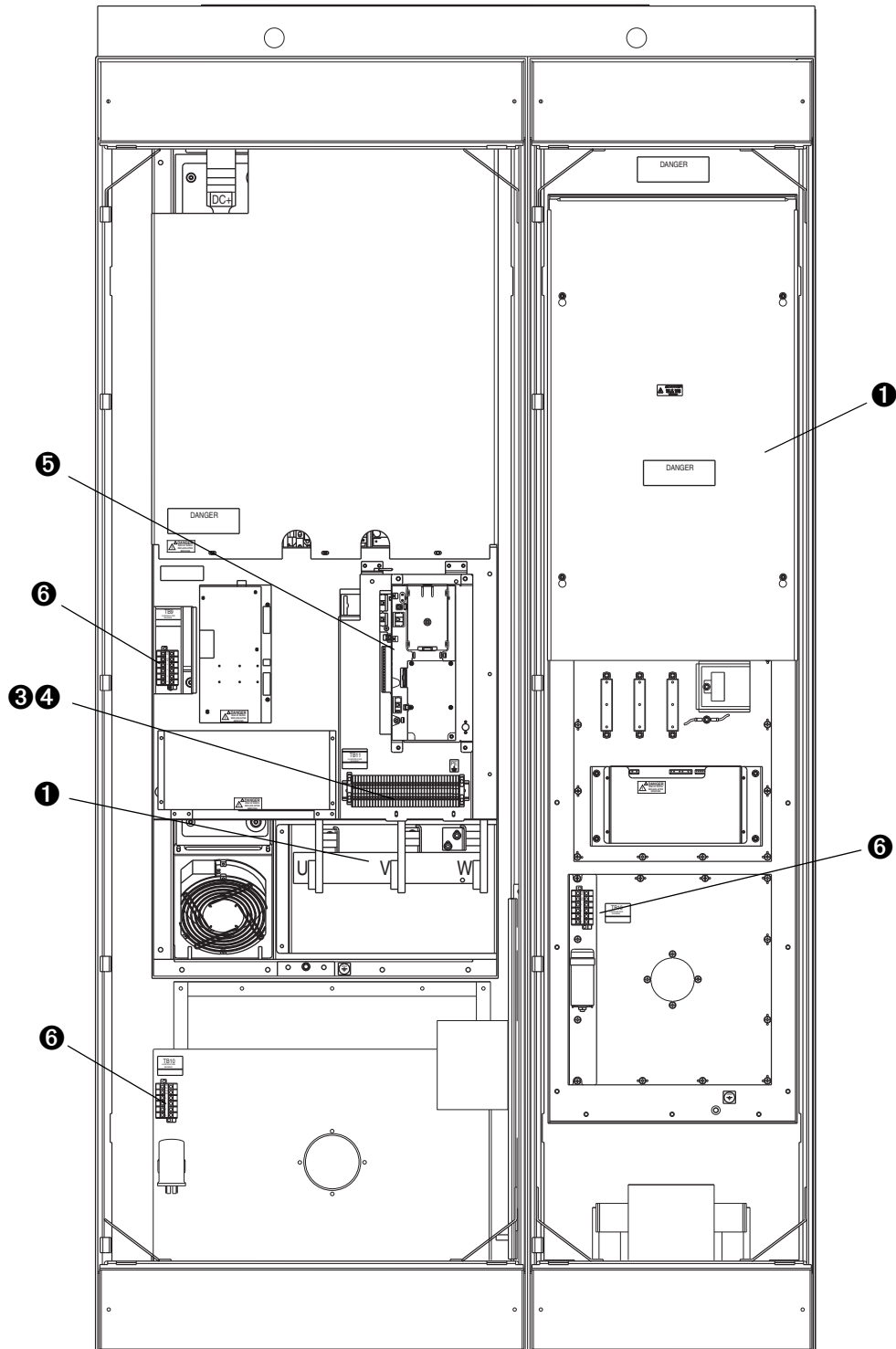

Frame 10
AC Input shown, DC Input Drives utilize the Inverter (Left) Bay only

Power Terminals

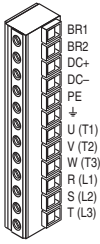
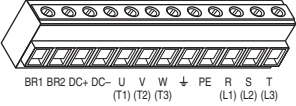
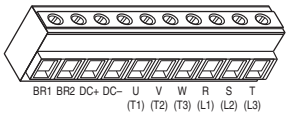
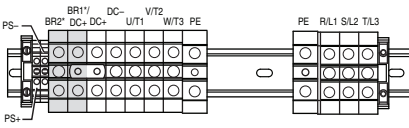
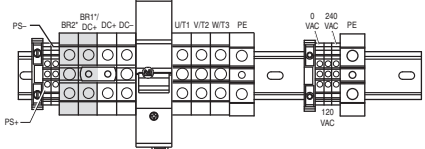
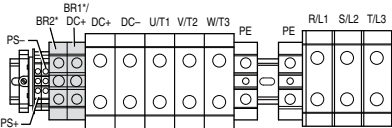
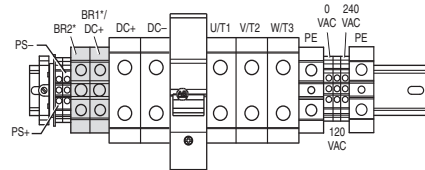
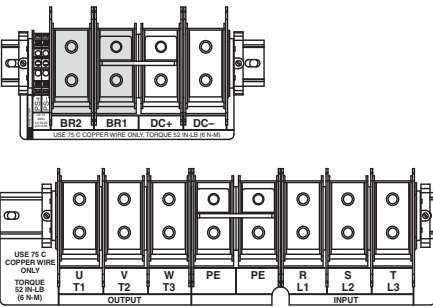
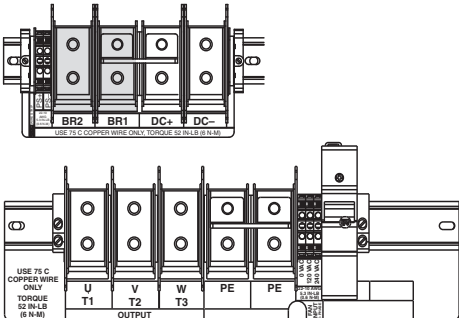
| Frame | Terminal Block | |
|-------|--|--|
| 0...1 |  | <p>* Note: Shaded BR1 & BR2 Terminals will only be present on drives ordered with the Brake Option.</p> |
| 2 |  | |
| 3...4 |  | |
| | AC Input | DC Input |
| 5 | <p>75 Hp, Normal Duty</p>  | <p>75 Hp, Normal Duty</p>  |
| | <p>100 Hp, Normal Duty</p>  | <p>100 Hp, Normal Duty</p>  |
| 6 | <p>125...200 Hp, Normal Duty</p>  | <p>125...200 Hp, Normal Duty</p>  |

| Frame | Terminal Block | |
|-------|----------------|----------|
| | AC Input | DC Input |
| 7 | | |
| 8...9 | | |
| 10 | | |

Fan Circuit Power Supply

Some drives utilize a fan transformer to power the internal fan(s). This transformer is sized specifically for the internal fan(s) and must not be used to power other circuitry. If your line voltage is different than the voltage class specified on the drive nameplate, changing the transformer taps will be required.

Frames 5...6 Fan Connections

| Drive Type | Enclosure | Rating (120V AC) | No. of Fans | Connect at ... | | | | | | | | | | |
|--|---|--------------------------------------|-------------|--|-------------------|-------------|-----|-------------|-----|-------------|-----|-------------|-----|--|
| DC Input | IP00, NEMA/UL Type Open | 100 VA (Frame 5) 138 VA (Frame 6) | 1 | Power Terminal Block Requires user supplied 120 or 240V AC. See page 36 for TB locations and terminal designations. | | | | | | | | | | |
| | IP20, NEMA/UL Type 1 IP54, NEMA/UL Type 12 | 100 VA (Frame 5) 138 VA (Frame 6) | 1 | | | | | | | | | | | |
| AC Input | IP00, NEMA/UL Type Open | 100 VA (Frame 5) 138 VA (Frame 6) | 1 | N/A (Connected internally) A transformer matches the input line voltage to the internal fan voltage. If line voltage is different than the voltage class specified on the drive nameplate, the transformer taps may require changing. The transformer is behind the Power Terminal Block. Access is gained by releasing the terminal block from the rail and removing the transformer cover plate. | | | | | | | | | | |
| | IP20, NEMA/UL Type 1 IP54, NEMA/UL Type 12 | 100 VA (Frame 5) 138 VA (Frame 6) | 1 | | | | | | | | | | | |
| <table border="1" style="margin-left: auto; margin-right: auto;"> <thead> <tr> <th>Primary Terminal Voltage</th> <th>Secondary Voltage</th> </tr> </thead> <tbody> <tr> <td>400/480V P2</td> <td>400</td> </tr> <tr> <td>600/690V P3</td> <td>600</td> </tr> <tr> <td>600/690V P2</td> <td>480</td> </tr> <tr> <td>600/690V P3</td> <td>600</td> </tr> </tbody> </table> | | | | Primary Terminal Voltage | Secondary Voltage | 400/480V P2 | 400 | 600/690V P3 | 600 | 600/690V P2 | 480 | 600/690V P3 | 600 | <ol style="list-style-type: none"> 1. Locate the small metal tab at the bottom of the end terminal block. 2. Press the tab-in and pull the top of the block out. Repeat for the next block if desired. 3. Remove the transformer cover plate. 4. Select the appropriate transformer tap. 5. Replace cover and terminal block. |
| Primary Terminal Voltage | Secondary Voltage | | | | | | | | | | | | | |
| 400/480V P2 | 400 | | | | | | | | | | | | | |
| 600/690V P3 | 600 | | | | | | | | | | | | | |
| 600/690V P2 | 480 | | | | | | | | | | | | | |
| 600/690V P3 | 600 | | | | | | | | | | | | | |

Frame 7

| Drive Type | Enclosure | Rating (120VAC) | No. of Fans | Connect at ... |
|------------|-------------------------|-----------------|-------------|---|
| DC Input | IP00, NEMA/UL Type Open | 250 VA | 1 | Power Terminal Block |
| | IP20, NEMA/UL Type 1 | 250 VA | 1 | Requires user supplied 120V AC. See page 40 for location. |
| AC Input | IP00, NEMA/UL Type Open | 250 VA | 1 | N/A (Connected internally) |
| | IP20, NEMA/UL Type 1 | 250 VA | 1 | |

Frame 8

| Drive Type | Enclosure | Rating (120VAC) | No. of Fans | Connect at ... |
|------------|-------------------------|-----------------|-------------|---|
| DC Input | IP00, NEMA/UL Type Open | 500 VA | 1 | TB9 |
| | IP20, NEMA/UL Type 1 | 500 VA | 1 | Requires user supplied 120V AC. See page 37 for TB location and page 42 for terminal designations. |
| AC Input | IP00, NEMA/UL Type Open | 500 VA | 1 | TB9 A transformer matches the input line voltage to the internal fan voltage. If line voltage is different than the voltage class specified on the drive nameplate, the transformer taps may require changing. |
| | IP20, NEMA/UL Type 1 | 500 VA | 1 | |

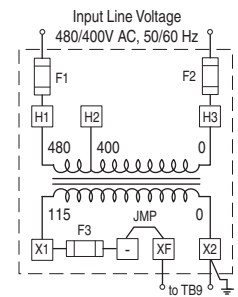
**Frame 9**

| Drive Type | Enclosure | Rating (120VAC) | No. of Fans | Connect at ... |
|------------|-------------------------|-----------------|-------------|---|
| DC Input | IP00, NEMA/UL Type Open | 500 VA | 2 | TB9 Requires user supplied 120V AC for cap. bank fan and phase monitor. Blower Terminal Block Three-phase power must be supplied to the Blower TB. See page 37 for TB locations and page 42 for terminal designations. |
| | IP20, NEMA/UL Type 1 | 500 VA | 2 | |
| AC Input | IP00, NEMA/UL Type Open | 500 VA | 2 | TB9 A transformer matches the input line voltage to the internal voltage used for the capacitor fan and phase detector module. If the line voltage is different than the voltage class specified on the drive nameplate, the transformer taps may require changing. |
| | IP20, NEMA/UL Type 1 | 500 VA | 2 | |

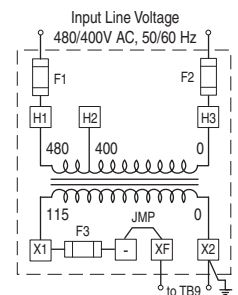
**Frame 9 Blower Operation**

Frame 9 drives use a single-phase capacitor bank fan and a three-phase blower for cooling. Proper phasing must be supplied to terminals R, S, and T of the Power Terminal Block (AC drives) or the Blower Terminal Block (DC drives) to assure correct blower rotation. To verify this, a Phase Monitor is used.

Frame 10

| Drive Type | Enclosure | Rating (120VAC) | No. of Fans | Connect at ... |
|------------|-------------------------|-----------------|-------------|--|
| DC Input | IP00, NEMA/UL Type Open | 1000 VA | 2 | TB9 & 10 |
| | IP20, NEMA/UL Type 1 | 1000 VA | 2 | Requires user supplied 120V AC. See page 38 for TB locations and page 42 for terminal designations. |
| AC Input | IP00, NEMA/UL Type Open | 1000 VA | 3 | TB9, 10 & 12 Requires user supplied 120V AC. See page 38 for TB locations and page 42 for terminal designations. |
| | IP20, NEMA/UL Type 1 | 1000 VA | 3 | TB9, 10 & 12 A transformer matches the input line voltage to the internal fan voltage. If line voltage is different than the voltage class specified on the drive nameplate, the transformer taps may require changing. |

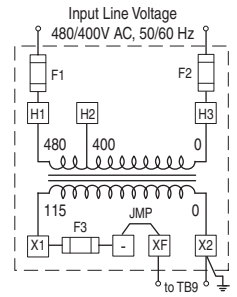

Fan/Blower Terminal Blocks - Frames 8...10

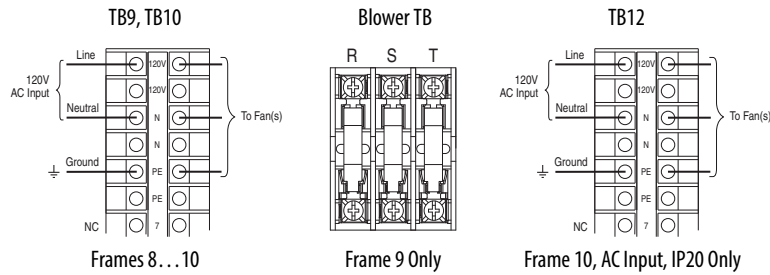

Fan Transformer Specifications/Fusing

| Frame | Rating | Recommended Fuses | |
|-------|---------|-------------------------------|----------------------------|
| | | Primary (Quantity 2) | Secondary (Quantity 1) |
| 8...9 | 500 VA | 2.8A, 600V AC, KLDR/ATQR Type | 6.25A, 250V AC, Time Delay |
| 10 | 1000 VA | 6A, 600V AC, KLDR/ATQR Type | 9A, 250V AC, Time Delay |

Three-Phase Blower Fusing

| Frame | Recommended Fuses (Quantity 3) |
|-------|--------------------------------|
| 9 | 5A, 600V AC, Time Delay |

Additional Frame 10 Wiring Requirement for IP00 AC Input Drives

The Inverter and Converter sections of Frame 10 AC Input IP00, NEMA/UL Type Open drives are shipped separately. Once installed, the following connections are required.

1. DC Link Choke Wiring
DC link chokes are supplied loose for customer mounting and wiring in IP00 drives. Refer to [DC Link Chokes – Frames 8...10](#) below.
2. Thermistor Wiring
Thermistor wiring is coiled loose in the Converter section for shipping. Locate the wire (labeled “To INV”) and route through the enclosure wall. Connect it to the mating connector above the HIM cradle.
3. Ground the drive chassis.

DC Link Chokes – Frames 8...10

DC Link Chokes are supplied with Frame 8...10 AC input drives.

| Frame | Type | DC Link Choke is supplied ... |
|-------|---------------------------------|-------------------------------|
| 8...9 | IP00, NEMA/UL Type Open | Mounted and wired |
| | IP20, NEMA/UL Type 1 | Mounted and wired |
| | IP00, NEMA/UL Type Open Roll-In | Loose without cables |
| 10 | IP00, NEMA/UL Type Open | Loose without cables |
| | IP20, NEMA/UL Type 1 | Mounted and wired |

I/O Wiring

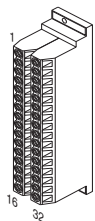

Standard Control Option – Frames 0...6

| No. | Signal | Factory Default | Description |
|-----|-------------------------------------|-----------------|---|
| 1 | Anlg Volts In 1 (-) | (2) | Isolated ⁽³⁾ , bipolar, differential, ±10V, 11 bit & sign, 88k ohm input impedance. |
| 2 | Anlg Volts In 1 (+) | | |
| 3 | Anlg Volts In 2 (-) | (2) | Isolated ⁽⁴⁾ , bipolar, differential, ±10V, 11 bit & sign, 88k ohm input impedance. |
| 4 | Anlg Volts In 2 (+) | | |
| 5 | Pot Common | - | For (+) and (-) 10V pot references. |
| 6 | Anlg Volts Out 1 (-) | (2) | Bipolar, ±10V, 11 bit & sign, 2k ohm minimum load. |
| 7 | Anlg Volts Out 1 (+) | | |
| 8 | Anlg Current Out 1 (-) | (2) | 4-20mA, 11 bit & sign, 400 ohm maximum load. |
| 9 | Anlg Current Out 1 (+) | | |
| 10 | Reserved for Future Use | | |
| 11 | Digital Out 1 – N.C. ⁽¹⁾ | Fault | Max. Resistive Load: 240V AC/30V DC – 1200VA, 150W Max. Current: 5A, Min. Load: 10mA Max. Inductive Load: 240V AC/30V DC – 840VA, 105W Max. Current: 3.5A, Min. Load: 10mA |
| 12 | Digital Out 1 Common | | |
| 13 | Digital Out 1 – N.O. ⁽¹⁾ | NOT Fault | |
| 14 | Digital Out 2 – N.C. ⁽¹⁾ | NOT Run | |
| 15 | Digital Out 2 Common | | |
| 16 | Digital Out 2 – N.O. ⁽¹⁾ | Run | |
| 17 | Anlg Current In 1 (-) | (2) | Isolated ⁽³⁾ , 4-20 mA, 11 bit & sign, 124 ohm input impedance. |
| 18 | Anlg Current In 1 (+) | | |
| 19 | Anlg Current In 2 (-) | (2) | Isolated ⁽⁴⁾ , 4-20 mA, 11 bit & sign, 124 ohm input impedance. |
| 20 | Anlg Current In 2 (+) | | |
| 21 | -10V DC Pot Ref. | - | 2k ohm minimum. |
| 22 | +10V DC Pot Ref. | - | |
| 23 | Reserved for Future Use | | |
| 24 | +24V DC ⁽⁵⁾ | - | Drive supplied logic input power. ⁽⁵⁾ |
| 25 | Digital In Common | - | |
| 26 | 24V Common ⁽⁵⁾ | - | Common for internal power supply. |
| 27 | Digital In 1 | Stop - CF | 115V AC, 50/60 Hz - Control & I/O Cat. No. option B Opto isolated Low State: less than 30V AC High State: greater than 100V AC, 5.0 mA |
| 28 | Digital In 2 | Start | |
| 29 | Digital In 3 | Auto/Man. | |
| 30 | Digital In 4 | Speed Sel 1 | 24V AC/DC, 50/60 Hz - Control & I/O Cat. No. option A |
| 31 | Digital In 5 | Speed Sel 2 | Opto isolated Low State: less than 5V AC/DC High State: greater than 20V AC/DC, 11.2 mA DC Digital Input Impedance: 35k ohm |
| 32 | Digital In 6 | Speed Sel 3 | |

Vector Control Option – Frames 0...6

| Signal | Factory Default | Description |
|--|-----------------|---|
| Analog In 1 (-) ⁽⁶⁾ | (2) | Isolated ⁽⁸⁾ , bipolar, differential, ±10V/0-20 mA, 11 bit & sign. For 0-20 mA, a jumper must be installed at terminals 17 & 18 (or 19 & 20). 88k ohm input impedance when configured for volt. & 95.3 ohm for current |
| Analog In 1 (+) ⁽⁶⁾ | | |
| Analog In 2 (-) ⁽⁶⁾ | | |
| Analog In 2 (+) ⁽⁶⁾ | | |
| Pot Common | - | For (+) and (-) 10V pot references. |
| Analog Out 1 (-) | (2) | Single-ended bipolar (current output is not bipolar), ±10V/0-20 mA, 11 bit & sign, Voltage mode - limit current to 5 mA. Current mode - max. load is 400 ohms. |
| Analog Out 1 (+) | | |
| Analog Out 2 (-) | | |
| Analog Out 2 (+) | | |
| HW PTC Input 1 | - | 1.8k ohm PTC, Internal 3.32k ohm pull-up resistor |
| Digital Out 1 – N.C. ⁽¹⁾ | Fault | Max. Resistive Load: 240V AC/30V DC – 1200VA, 150W Max. Current: 5A, Min. Load: 10 mA Max. Inductive Load: 240V AC/30V DC – 840VA, 105W Max. Current: 3.5A, Min. Load: 10 mA |
| Digital Out 1 Common | | |
| Digital Out 1 – N.O. ⁽¹⁾ | NOT Fault | |
| Digital Out 2 – N.C. ⁽¹⁾ | NOT Run | |
| Digital Out 2/3 Com. | | |
| Digital Out 3 – N.O. ⁽¹⁾ | Run | |
| Current In Jumper ⁽⁶⁾ – Analog In 1 | - | Placing a jumper across terminals 17 & 18 (or 19 & 20) configures that analog input for current. |
| Current In Jumper ⁽⁶⁾ – Analog In 2 | - | |
| -10VDC Pot Ref. | - | 2k ohm minimum load. |
| +10VDC Pot Ref. | - | |
| HW PTC Input 2 | - | See above |
| +24V DC ⁽⁵⁾ | - | Drive supplied logic input power. ⁽⁵⁾ |
| Digital In Common | - | |
| 24V Common ⁽⁵⁾ | - | Common for internal power supply. |
| Digital In 1 ⁽⁷⁾ | Stop - CF | 115V AC, 50/60 Hz - Control & I/O Cat. No. option D Opto isolated Low State: less than 30V AC High State: greater than 100V AC, 5.7 mA |
| Digital In 2 ⁽⁷⁾ | Start | |
| Digital In 3 ⁽⁷⁾ | Auto/Man. | |
| Digital In 4 ⁽⁷⁾ | Speed Sel 1 | 24V DC - Control & I/O Cat. No. option C |
| Digital In 5 ⁽⁷⁾ | Speed Sel 2 | Opto isolated Low State: less than 5V DC High State: greater than 20V DC, 10 mA DC Digital Input Impedance: 21k ohm |
| Digital In 6/Hardware Enable ⁽⁷⁾ , see pg. 46 | Speed Sel 3 | |

- (1) Contacts in unpowered state. Any relay programmed as Fault or Alarm energizes (picks up) when power is applied to drive and deenergize (drop out) when a fault or alarm exists. Relays selected for other functions energize only when that condition exists and deenergizes when condition is removed.
- (2) These inputs/outputs are dependant on a number of parameters.
- (3) Differential Isolation - External source must be maintained at less than 160V with respect to PE. Input provides high common mode immunity.
- (4) Differential Isolation - External source must be less than 10V with respect to PE.
- (5) 150 mA maximum load designed to power digital inputs only. Not present on 115V versions.
- (6) **Important:** 0...20 mA operation requires a jumper at terminals 17 & 18 (or 19 & 20). Drive damage can occur if jumper is not installed.
- (7) A 10k ohm, 2 watt burden resistor must be installed on each digital input when using a triac type device. The resistor is installed between each digital input and neutral /common.
- (8) Differential Isolation - External source must be maintained at less than 160V with respect to PE. Input provides high common mode immunity.

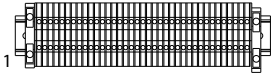

Vector Control Option – Frames 7...10

| No. | Signal | Factory Default | Description |
|-----|--|-----------------|---|
| 1 | Analog In 1 (-) ⁽¹⁾ | (3) | Isolated ⁽⁴⁾ , bipolar, differential, $\pm 10V/4-20mA$, 11 bit & sign, 88k ohm input impedance. For 4-20mA, a jumper must be installed at terminals 17 & 18 (or 19 & 20). |
| 2 | Analog In 1 (+) ⁽¹⁾ | | |
| 3 | Analog In 2 (-) ⁽¹⁾ | | |
| 4 | Analog In 2 (+) ⁽¹⁾ | | |
| 5 | Pot Common | - | For (+) and (-) 10V pot references. |
| 6 | Analog Out 1 (-) | (3) | Bipolar (current output is not bipolar), $\pm 10V/4-20mA$, 11 bit & sign, voltage mode - limit current to 5 mA. Current mode - max. load resistance is 400 ohms. |
| 7 | Analog Out 1 (+) | | |
| 8 | Analog Out 2 (-) | | |
| 9 | Analog Out 2 (+) | | |
| 10 | HW PTC Input 1 | - | 1.8k ohm PTC, Internal 3.32k ohm pull-up resistor |
| 11 | Digital Out 1 – N.C. ⁽²⁾ | Fault | Max. Resistive Load: 240V AC/30V DC – 1200VA, 150W Max. Current: 5A, Min. Load: 10mA Max. Inductive Load: 240V AC/30V DC – 840VA, 105W Max. Current: 3.5A, Min. Load: 10mA |
| 12 | Digital Out 1 Common | | |
| 13 | Digital Out 1 – N.O. ⁽²⁾ | NOT Fault | |
| 14 | Digital Out 2 – N.C. ⁽²⁾ | NOT Run | |
| 15 | Digital Out 2/3 Com. | | |
| 16 | Digital Out 3 – N.O. ⁽²⁾ | Run | |
| 17 | Current In Jumper ⁽¹⁾ – Analog In 1 | | Placing a jumper across terminals 17 & 18 (or 19 & 20) configures that analog input for current. |
| 18 | | | |
| 19 | Current In Jumper ⁽¹⁾ – Analog In 2 | | |
| 20 | | | |
| 21 | -10V Pot Reference | - | 2k ohm minimum load. |
| 22 | +10V Pot Reference | - | |
| 23 | HW PTC Input 2 | - | See above |
| 24 | +24V DC ⁽⁵⁾ | - | Drive supplied logic input power. ⁽⁵⁾ |
| 25 | Digital In Common | - | |
| 26 | 24V Common ⁽⁵⁾ | - | Common for internal power supply. |
| 27 | Digital In 1 | Stop - CF | 115V AC, 50/60 Hz - Control & I/O Cat. No. option D |
| 28 | Digital In 2 | Start | Opto isolated Low State: less than 30V AC |
| 29 | Digital In 3 | Auto/Man. | High State: greater than 100V AC |
| 30 | Digital In 4 | Speed Sel 1 | 24V DC - Control & I/O Cat. No. option C |
| 31 | Digital In 5 | Speed Sel 2 | Opto isolated Low State: less than 5V DC |
| 32 | Digital In 6/Hardware Enable, see pg. 46 | Speed Sel 3 | High State: greater than 20V DC 11.2 mA DC |
| 33 | Digital Out 4 – N.C. | Fault | Dedicated fault output - Not user configurable. Relay energizes (picks up) when power is applied to the drive and deenergizes (drops out) when a fault exists. See Terminals 11-16 for specs. |
| 34 | Digital Out 4 Common | | |
| 35 | Digital Out 4 – N.O. | NOT Fault | |
| PS+ | Aux. Control Power (+) | | |
| PS- | Aux. Control Power (-) | | |
| PE | PE Ground | | PE Ground |
| PE | PE Ground | | PE Ground |

- (1) **Important:** 0...20mA operation requires a jumper at terminals 17 & 18 (or 19 & 20). Drive damage can occur if jumper is not installed.
- (2) Contacts in unpowered state. Any relay programmed as Fault or Alarm energizes (picks up) when power is applied to the drive and deenergizes (drops out) when a fault or alarm exists. Relays selected for other functions energize only when that condition exists and deenergize when condition is removed.
- (3) These inputs/outputs are dependant on a number of parameters.
- (4) Differential Isolation - External source must be maintained at less than 160V with respect to PE. Input provides high common mode immunity.
- (5) 150mA maximum Load. Not present on 115V versions.

Hardware Enable Circuitry (Vector Control Only)

By default, the user can program a digital input as an Enable input. The status of this input is interpreted by drive software. If the application requires the drive to be disabled without software interpretation, a “dedicated” hardware enable configuration can be utilized. This is done by removing a jumper and wiring the enable input to “Digital In 6.”

Encoder Interface Option (Vector Control Only)

Encoder Terminal Designations

| No. | Description (refer to specifications on page 11) | |
|-----|---|---|
| | | |
| 8 | +12V ⁽¹⁾ DC Power | Internal power source 250 mA. |
| 7 | +12V ⁽¹⁾ DC Return (Common) | |
| 6 | Encoder Z (NOT) | Pulse, marker or registration input. ⁽²⁾ |
| 5 | Encoder Z | |
| 4 | Encoder B (NOT) | Quadrature B input. |
| 3 | Encoder B | |
| 2 | Encoder A (NOT) | Single channel or quadrature A input. |
| 1 | Encoder A | |

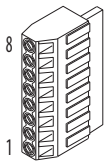

- (1) Jumper selectable +5/12V is available on 20B-ENC-1 Encoder Boards.
- (2) Z channel can be used as a pulse input while A & B are used for encoder.

Sample Encoder Wiring

| I/O | Connection Example |
|---|--------------------|
| Encoder Power –Internal Drive Power Internal (drive) 12V DC, 250mA ⁽¹⁾ | |
| Encoder Signal –Single-Ended, Dual Channel⁽²⁾ | |

| I/O | Connection Example |
|---|--------------------|
| Encoder Power –External Power Source | |
| Encoder Signal –Differential, Dual Channel | |

- (1) SHLD connection is on drive chassis (see [page 36](#)).
- (2) Example applies to 20B-ENC-1 only.

I/O Wiring Examples – Standard & Vector Control Options

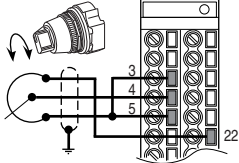
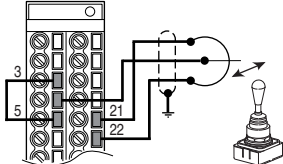
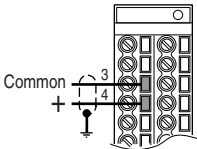
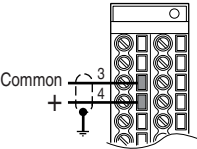
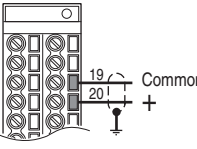
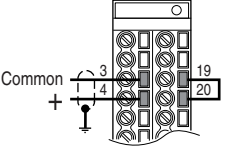
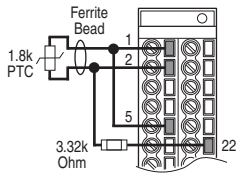
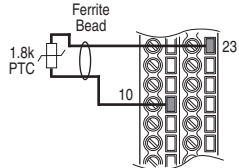
| Input/Output | Connection Example | Required Parameter Changes |
|--|---|--|
| Potentiometer Unipolar Speed Reference ⁽¹⁾ 10k Ohm Pot. Recommended (2k Ohm Minimum) |  | <ul style="list-style-type: none"> Adjust Scaling: Parameters 91/92 and 325/326 View Results: Parameter 002 |
| Joystick Bipolar Speed Reference ⁽¹⁾ ±10V Input |  | <ul style="list-style-type: none"> Set Direction Mode: Parameter 190 = "1, Bipolar" Adjust Scaling: Parameters 91/92 and 325/326 View Results: Parameter 002 |
| Analog Input Bipolar Speed Reference ±10V Input |  | <ul style="list-style-type: none"> Set Direction Mode: Parameter 190 = "1, Bipolar" Adjust Scaling: Parameters 91/92 and 325/326 View Results: Parameter 002 |
| Analog Voltage Input Unipolar Speed Reference 0 to +10V Input |  | <ul style="list-style-type: none"> Configure Input with parameter 320 Adjust Scaling: Parameters 91/92 and 325/326 View results: Parameter 002 |
| Analog Current Input Unipolar Speed Reference Standard 4-20 mA Input |  | <ul style="list-style-type: none"> Configure Input for Current: Parameter 320, Bit 1 = "1, Current" Adjust Scaling: Parameters 91/92 and 325/326 View Results: Parameter 002 |
| Analog Current Input Unipolar Speed Reference Vector 0-20 mA Input |  | <ul style="list-style-type: none"> Configure Input for Current: Parameter 320 and add jumper at appropriate terminals Adjust Scaling: Parameters 91/92 and 325/326 View results: Parameter 002 |
| Analog Input, PTC Vector PTC OT set > 5V PTC OT cleared < 4V PTC Short < 0.2V |  | <ul style="list-style-type: none"> Set Fault Config 1: Parameter 238, bit 7 = "Enabled" Set Alarm Config 1: Parameter 259, bit 11 = "Enabled" View Drive Alarm 1: Parameter 211, bit 11 = "True" |
| HW PTC Input Series B Only PTC OT set > 5V PTC OT cleared < 4V PTC Short < 0.2V |  | <ul style="list-style-type: none"> Set Fault Config 1: Parameter 238, bit 13 = "Enabled" Set Alarm Config 1: Parameter 259, bit 18 = "Enabled" View Status: Drive Alarm 1: Parameter 211, bit 18 = "True" |

(1) Refer to the PowerFlex 700 User Manual for important bipolar wiring information.

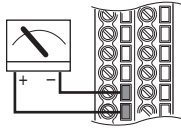
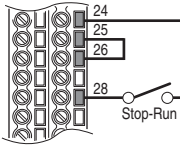
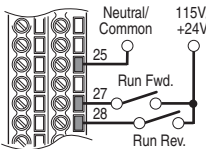
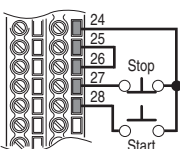
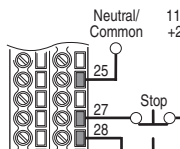
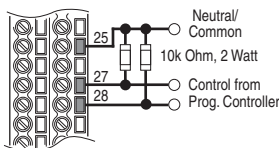
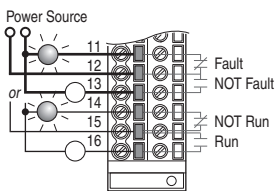
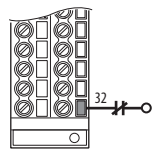
| Input/Output | Connection Example | Required Parameter Changes |
|--|---|---|
| <p>Analog Output $\pm 10V$, 0-20 mA Bipolar +10V Unipolar (<i>shown</i>) <u>Standard Control</u> 4-20 mA Unipolar (use term. 8 & 9)</p> |  | <ul style="list-style-type: none"> • Configure with Parameter 340 • Select Source Value: Parameter 384, [Digital Out1 Sel] • Adjust Scaling: Parameters 343/344 |
| <p>2-Wire Control Non-Reversing⁽¹⁾ 24V DC internal supply</p> |  | <ul style="list-style-type: none"> • Disable Digital Input:#1: Parameter 361 = "0, Unused" • Set Digital Input #2: Parameter 362 = "7, Run" • Set Direction Mode: Parameter 190 = "0, Unipolar" |
| <p>2-Wire Control Reversing⁽¹⁾ External supply (I/O Board dependent)</p> |  | <ul style="list-style-type: none"> • Set Digital Input:#1: Parameter 361 = "8, Run Forward" • Set Digital Input #2: Parameter 362 = "9, Run Reverse" |
| <p>3-Wire Control Internal supply</p> |  | <ul style="list-style-type: none"> • No Changes Required |
| <p>3-Wire Control External supply (I/O Board dependent). Requires 3-wire functions only ([Digital In1 Sel]). Using 2-wire selections will cause a type 2 alarm.</p> |  | <ul style="list-style-type: none"> • No Changes Required |
| <p>Digital Input PLC Output Card (Board dependent).</p> |  | <ul style="list-style-type: none"> • No Changes Required |
| <p>Digital Output Relays shown in powered state with drive faulted. See page 44. <u>Standard Control</u> 1 relay at terminals 14-16. Vector Control 2 relays at terminals 14-16.</p> |  | <ul style="list-style-type: none"> • Select Source to Activate: Parameters 380/384 |
| <p>Enable Input</p> |  | <ul style="list-style-type: none"> • <u>Standard Control</u> Configure with parameter 366 • <u>Vector Control</u> Configure with parameter 366 For dedicated hardware Enable: Remove Jumper J10 (see page 46) |

(1) **Important:** Programming inputs for 2 wire control deactivates all HIM Start buttons.

Mounting

Frame/Rating Cross Reference

AC Input

| Frame | 208/240 | | 400V | | 480V | | 600V | | 690V | |
|-----------|---------|-------|-------|-------|-------|-------|-------|-------|-------|-------|
| | ND Hp | HD Hp | ND kW | HD kW | ND Hp | HD Hp | ND Hp | HD Hp | ND kW | HD kW |
| 0 | 0.5 | 0.33 | 0.37 | 0.25 | 0.5 | 0.33 | 1 | 0.5 | – | – |
| | 1 | 0.75 | 0.75 | 0.55 | 1 | 0.75 | 2 | 1 | – | – |
| | – | – | 1.5 | 0.75 | 2 | 1.5 | 3 | 2 | – | – |
| | – | – | 2.2 | 1.5 | 3 | 2 | 5 | 3 | – | – |
| | – | – | 4 | 2.2 | 5 | 3 | 7.5 | 5 | – | – |
| | – | – | 5.5 | 4 | 7.5 | 5 | – | – | – | – |
| 1 | 2 | 1.5 | 7.5 | 5.5 | 10 | 7.5 | 10 | 7.5 | – | – |
| | 3 | 2 | 11 | 7.5 | 15 | 10 | 15 | 10 | – | – |
| | 5 | 3 | – | – | – | – | – | – | – | – |
| | 7.5 | 5 | – | – | – | – | – | – | – | – |
| 2 | 10 | 7.5 | 15 | 11 | 20 | 15 | 20 | 15 | – | – |
| | – | – | 18.5 | 15 | 25 | 20 | 25 | 20 | – | – |
| 3 | 15 | 10 | 22 | 18.5 | 30 | 25 | 30 | 25 | – | – |
| | 20 | 15 | 30 | 22 | 40 | 30 | 40 | 30 | – | – |
| | – | – | 37 | 30 | 50 | 40 | 50 | 40 | – | – |
| 4 | 25 | 20 | 45 | 37 | 60 | 50 | 60 | 50 | – | – |
| | 30 | 25 | – | – | – | – | – | – | – | – |
| 5 | 40 | 30 | 55 | 45 | 75 | 60 | 75 | 60 | 45 | 37.5 |
| | 50 | 40 | 75 | 55 | 100 | 75 | 100 | 75 | 55 | 45 |
| | – | – | – | – | – | – | – | – | 75 | 55 |
| | – | – | – | – | – | – | – | – | 90 | 75 |
| 6 | 60 | 50 | 90 | 75 | 125 | 100 | 125 | 100 | 110 | 90 |
| | 75 | 60 | 110 | 90 | 150 | 125 | 150 | 125 | 132 | 110 |
| | 100 | 75 | 132 | 110 | 200 | 150 | – | – | – | – |
| 7 | – | – | 160 | 150 | 250 | 200 | – | – | – | – |
| | – | – | 180 | 180 | 250 | 250 | – | – | – | – |
| 8 | – | – | 200 | 180 | 300 | 250 | – | – | – | – |
| | – | – | 240 | 200 | 350 | 300 | – | – | – | – |
| | – | – | 280 | 240 | 400 | 350 | – | – | – | – |
| | – | – | 300 | 280 | 450 | 400 | – | – | – | – |
| | – | – | 350 | 300 | 500 | 450 | – | – | – | – |
| 9 | – | – | 400 | 350 | 600 | 500 | – | – | – | – |
| 10 | – | – | 500 | 400 | 700 | 600 | – | – | – | – |

DC Input

| Frame | 325V | | 540V | | 650V | | 810V | | 932V | |
|-----------|-------|-------|-------|-------|-------|-------|-------|-------|-------|-------|
| | ND Hp | HD Hp | ND kW | HD kW | ND Hp | HD Hp | ND Hp | HD Hp | ND kW | HD kW |
| 0 | 0.5 | 0.33 | – | – | 0.5 | 0.33 | 1 | 0.75 | – | – |
| | 1 | 0.75 | – | – | 1 | 0.75 | 2 | 1.5 | – | – |
| | – | – | – | – | 2 | 1.5 | 3 | 2 | – | – |
| | – | – | – | – | 3 | 2 | 5 | 3 | – | – |
| | – | – | – | – | 5 | 3 | 7.5 | 5 | – | – |
| | – | – | – | – | 7.5 | 5 | 10 | 7.5 | – | – |
| 1 | 2 | 1.5 | 0.37 | 0.25 | 10 | 7.5 | 15 | 10 | – | – |
| | 3 | 2 | 0.75 | 0.55 | 15 | 10 | – | – | – | – |
| | 5 | 3 | 1.5 | 0.75 | – | – | – | – | – | – |
| | 7.5 | 5 | 2.2 | 1.5 | – | – | – | – | – | – |
| | – | – | 4 | 2.2 | – | – | – | – | – | – |
| | – | – | 5.5 | 4 | – | – | – | – | – | – |
| | – | – | 7.5 | 5.5 | – | – | – | – | – | – |
| | – | – | 11 | 7.5 | – | – | – | – | – | – |
| 2 | 10 | 7.5 | 15 | 11 | 20 | 15 | 20 | 15 | – | – |
| | – | – | 18.5 | 15 | 25 | 20 | 25 | 20 | – | – |
| 3 | 15 | 10 | 22 | 18.5 | 30 | 25 | 30 | 25 | – | – |
| | 20 | 15 | 30 | 22 | 40 | 30 | 40 | 30 | – | – |
| | – | – | 37 | 30 | 50 | 40 | 50 | 40 | – | – |
| 4 | 25 | 20 | 45 | 37 | 60 | 50 | 60 | 50 | – | – |
| | 30 | 25 | – | – | – | – | – | – | – | – |
| 5 | 40 | 30 | 55 | 45 | 75 | 60 | 100 | 75 | 45 | 37.5 |
| | 50 | 40 | – | – | 100 | 75 | – | – | 90 | 75 |
| 6 | 60 | 50 | 75 | 55 | 125 | 100 | 150 | 125 | 132 | 110 |
| | 75 | 60 | 90 | 75 | 150 | 125 | – | – | – | – |
| | 100 | 75 | 110 | 90 | – | – | – | – | – | – |
| | – | – | 132 | 110 | 200 | 150 | – | – | – | – |
| 7 | – | – | 160 | 150 | 250 | 200 | – | – | – | – |
| | – | – | 180 | 180 | 250 | 250 | – | – | – | – |
| 8 | – | – | 200 | 180 | 300 | 250 | – | – | – | – |
| | – | – | 240 | 200 | 350 | 300 | – | – | – | – |
| | – | – | 280 | 240 | 400 | 350 | – | – | – | – |
| | – | – | 300 | 280 | 450 | 400 | – | – | – | – |
| | – | – | 350 | 300 | 500 | 450 | – | – | – | – |
| 9 | – | – | 400 | 350 | 600 | 500 | – | – | – | – |
| 10 | – | – | 500 | 400 | 700 | 600 | – | – | – | – |

Operating Temperatures

PowerFlex 700 drives are designed to operate at 0° to 40° C ambient. To operate the drive in installations between 41° and 50° C, see the information below and refer to pages [25...32](#) for exceptions.

Acceptable Surrounding Air Temperature & Required Actions

| Enclosure Rating | Temperature Range | Drive |
|--|---|---|
| IP20, NEMA/UL Type 1 (with Top Label) ⁽¹⁾ | 0...40 °C (0...104 °F) | Frames 0...4, All Ratings |
| | 0...50 °C (0...122 °F) | Frames 5...6, Most Ratings ⁽²⁾ |
| IP20, NEMA/UL Type Open (Top Label Removed) ⁽¹⁾ | 0...50 °C (0...122 °F) | Frames 0...6, Most Ratings ⁽²⁾ |
| | 0...45 °C (0...113 °F) | 20BC072 Only |
| IP00, NEMA/UL Type Open (Top Label & Vent Plate Removed) | 0...50 °C (0...122 °F) | 20BC072 Only ⁽³⁾ |
| Flange Mount Front: IP00, NEMA/UL Type Open Back/Heat Sink: IP54, NEMA/UL Type 12 | 0...55 °C (0...131 °F) Front (Inside Encl.) | Frames 5...6 |
| | 0...40 °C (0...104 °F) Back (External) | |
| Stand-alone/Wall Mount IP54, NEMA/UL Type 12 | 0...40 °C (0...104 °F) | Frames 5...6 |
| IP20, NEMA/UL Type 1 | 0...40 °C (0...104 °F) | Frames 7...10 |
| IP00, NEMA/UL Type Open/Flange Mount Front: IP00, NEMA/UL Type Open Back/Heat Sink: IP54, NEMA12 | 0...65 °C (0...149 °F) Control Board | Frames 7...10 |
| | 0...40 °C (0...104 °F) Heat Sink Entry Air | |
| Roll In Front: IP00, NEMA/UL Type Open Back/Heat Sink: IP54, NEMA12 | 0...65 °C (0...149 °F) Control Board | Frames 8...9 |
| | 0...40 °C (0...104 °F) Heat Sink Entry Air | |

(1) Removing the adhesive top label from the drive changes the NEMA/UL enclosure rating from Type 1 to Open. Frames 5 and 6 do not have a top label.

(2) Refer to pages [25...32](#) for exceptions.

(3) To remove vent plate (see [page 53](#) for location), lift top edge of plate from the chassis. Rotate the plate out from the back plate.

Minimum Mounting Clearances

Frames 0...6

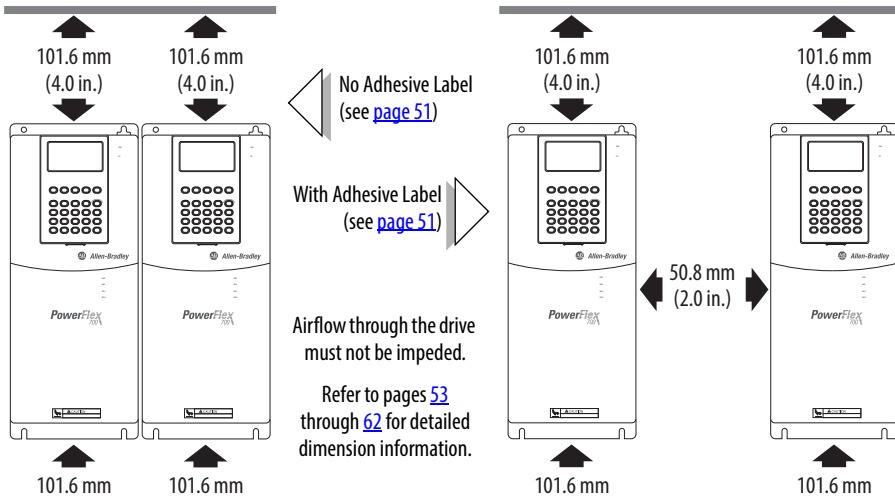

Specified vertical clearance requirements (indicated above) are intended to be from the drive to the closest object that can restrict airflow through the drive heat sink and chassis. The drive must be mounted in a vertical orientation as shown and must make full contact with the mounting surface. Do not use standoffs or spacers. In addition, inlet air temperature must not exceed the product specification.

Frames 7...10

The drive must be mounted with sufficient space at the top, sides, and front of the cabinet to allow for proper heat dissipation.

| Frame | Recommendations |
|--------|--|
| 7 | Minimum of 152 mm (6.0 in.) at the top and bottom of the enclosure and 102 mm (4.0 in.) on the sides. Flange Mount - Minimum of 152 mm (6.0 in.) at the back of the enclosure (flange mount surface to wall). |
| 8...10 | Minimum of 152 mm (6.0 in.) at the top of the enclosure. Additionally, allow a minimum of 102 mm (4.0 in.) on each side OR 152 mm (6.0 in.) in the back. Flange Mount - Minimum of 102 mm (4.0 in.) on each side. |

Dimensions and Weights

Frames 0...3 – IP20, NEMA/UL Type 1

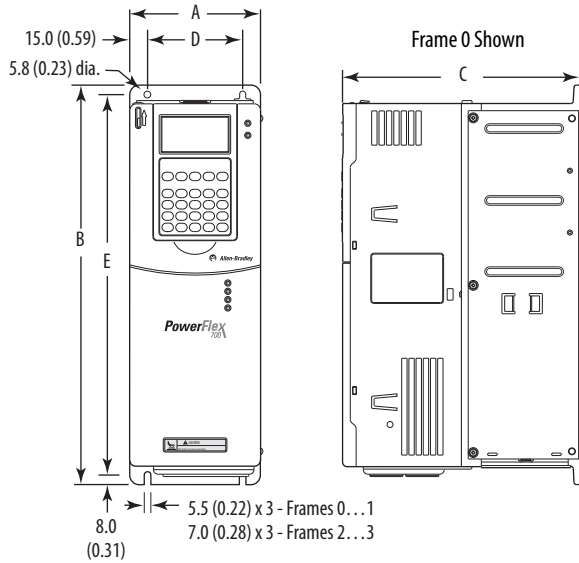

| Frame | A | B | C | D | E | Weight ⁽¹⁾ kg (lbs.) | |
|-------|--------------|---------------|--------------|--------------|---------------|---------------------------------|-------------------|
| | | | | | | Drive | Drive & Packaging |
| 0 | 110.0 (4.33) | 336.0 (13.23) | 200.0 (7.87) | 80.0 (3.15) | 320.0 (12.60) | 5.22 (11.5) | 8.16 (18) |
| 1 | 135.0 (5.31) | 336.0 (13.23) | 200.0 (7.87) | 105.0 (4.13) | 320.0 (12.60) | 7.03 (15.5) | 9.98 (22) |
| 2 | 222.0 (8.74) | 342.5 (13.48) | 200.0 (7.87) | 192.0 (7.56) | 320.0 (12.60) | 12.52 (27.6) | 15.20 (33.5) |
| 3 | 222.0 (8.74) | 517.5 (20.37) | 200.0 (7.87) | 192.0 (7.56) | 495.0 (19.49) | 18.55 (40.9) | 22.68 (50) |

(1) Weights include HIM and Standard I/O.

Dimensions are in millimeters and (inches)

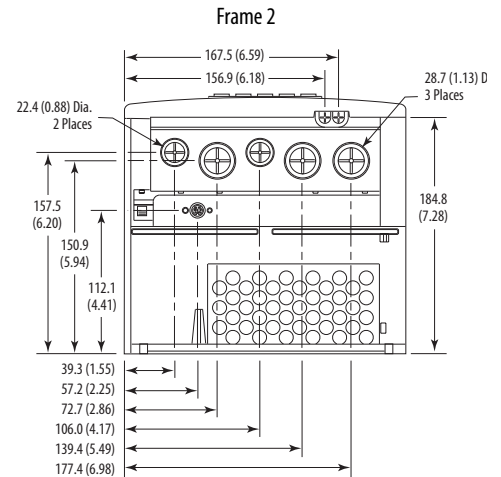
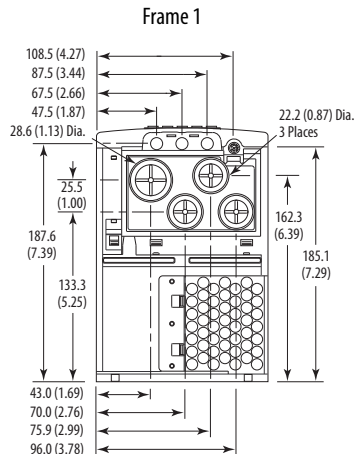
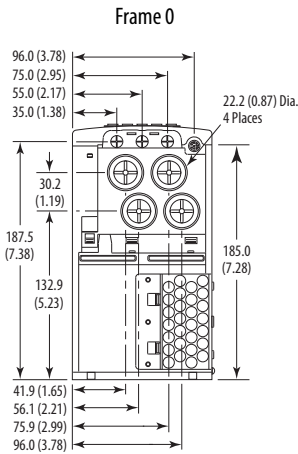

Frame 3
All except 50 Hp, 480V (37 kW, 400V)

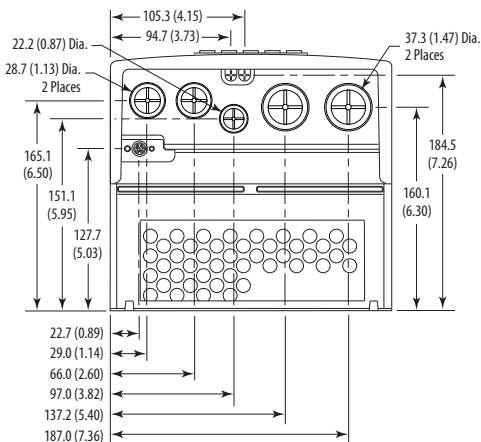

Frame 3
50 Hp, 480V (37 kW, 400V) Normal Duty Drive

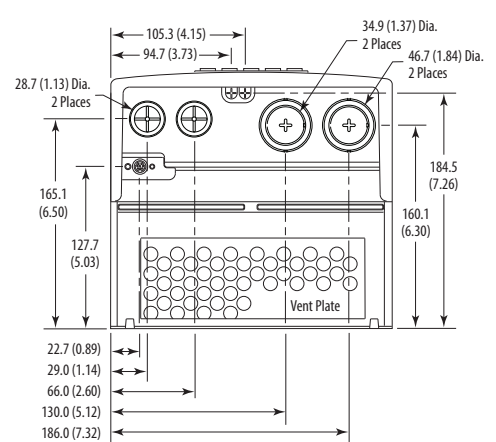

Frame 4 – IP20, NEMA/UL Type 1

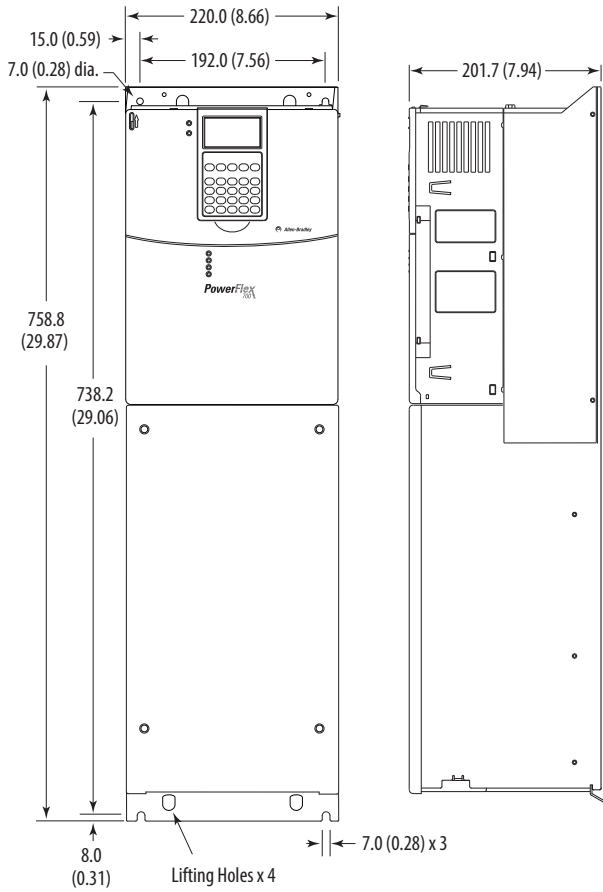

Dimensions are in millimeters and (inches)

| Frame | Approx. Weight ⁽¹⁾ kg (lbs.) | |
|-------|---|-------------------|
| | Drive | Drive & Packaging |
| 4 | 24.49 (54.0) | 29.03 (64.0) |

(1) Weights include HIM and Standard I/O.

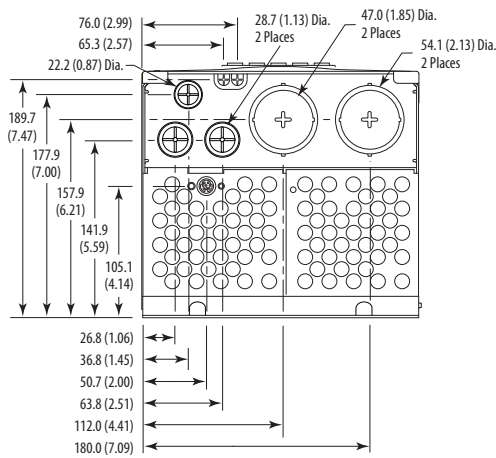

Frame 5 – IP20, NEMA/UL Type 1

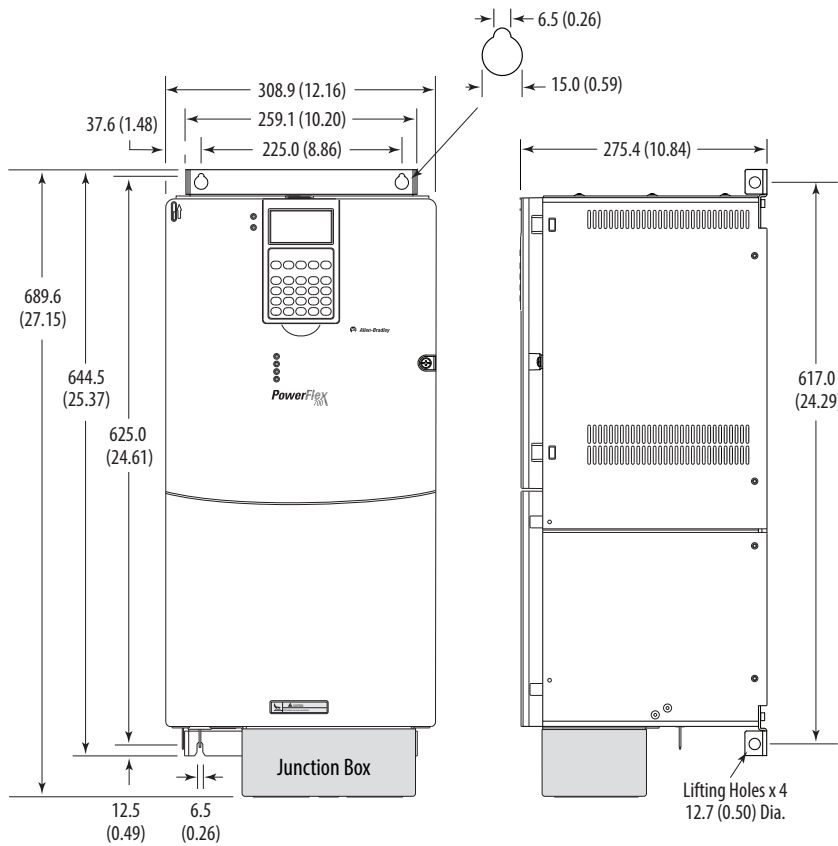

| Frame | Approx. Weight ⁽¹⁾ kg (lbs.) | |
|-------|---|-------------------|
| | Drive | Drive & Packaging |
| 5 | 37.19 (82.0) | 49.50 (109.0) |

(1) Weights include HIM and Standard I/O. Add 2.70 kg (6.0 lbs.) for the 20BC140 drive.

30 kW, 208V (40 Hp, 240V)
 55 kW, 400V (75 Hp, 480V)
 45/55/75 kW, 690V (75 Hp, 600V)

37 kW, 208V (50 Hp, 240V)
 75 kW, 400V (100 Hp, 480V)
 90kW, 690V (100 Hp, 600V)

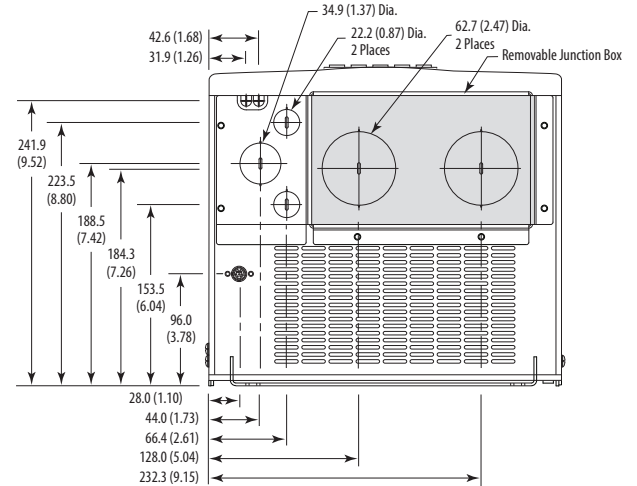
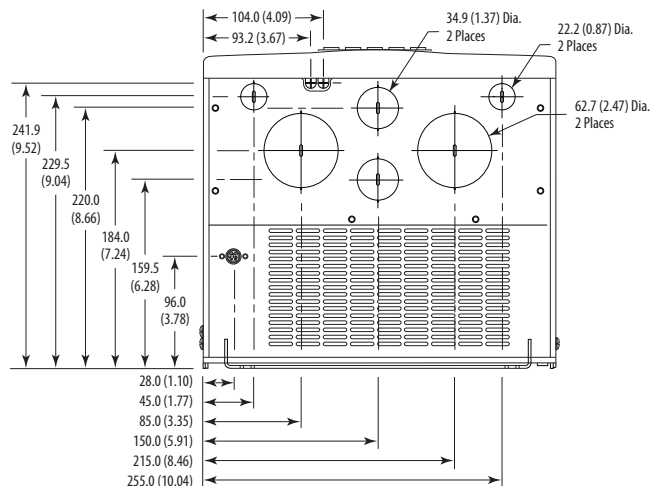

Frame 5 – IP54, NEMA Type 12 Standalone (400...690V drives only)

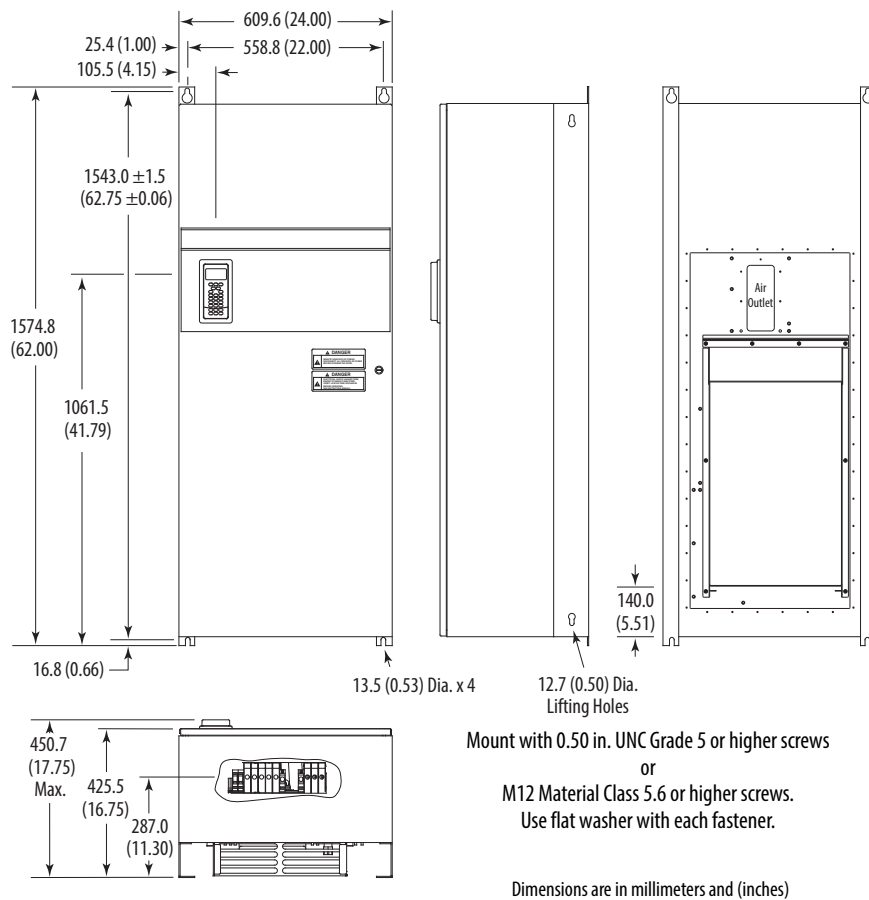

| Frame | Description | Approx. Weight ⁽¹⁾ kg (lbs.) | |
|-------|-------------|---|-------------------|
| | | Drive | Drive & Packaging |
| 5 | Standalone | 102.51 (226.0) | 154.68 (341.0) |

(1) Weights include HIM and Standard I/O.

Frame 5 – IP54, NEMA Type 12 Flange Mount (400...690V drives only)

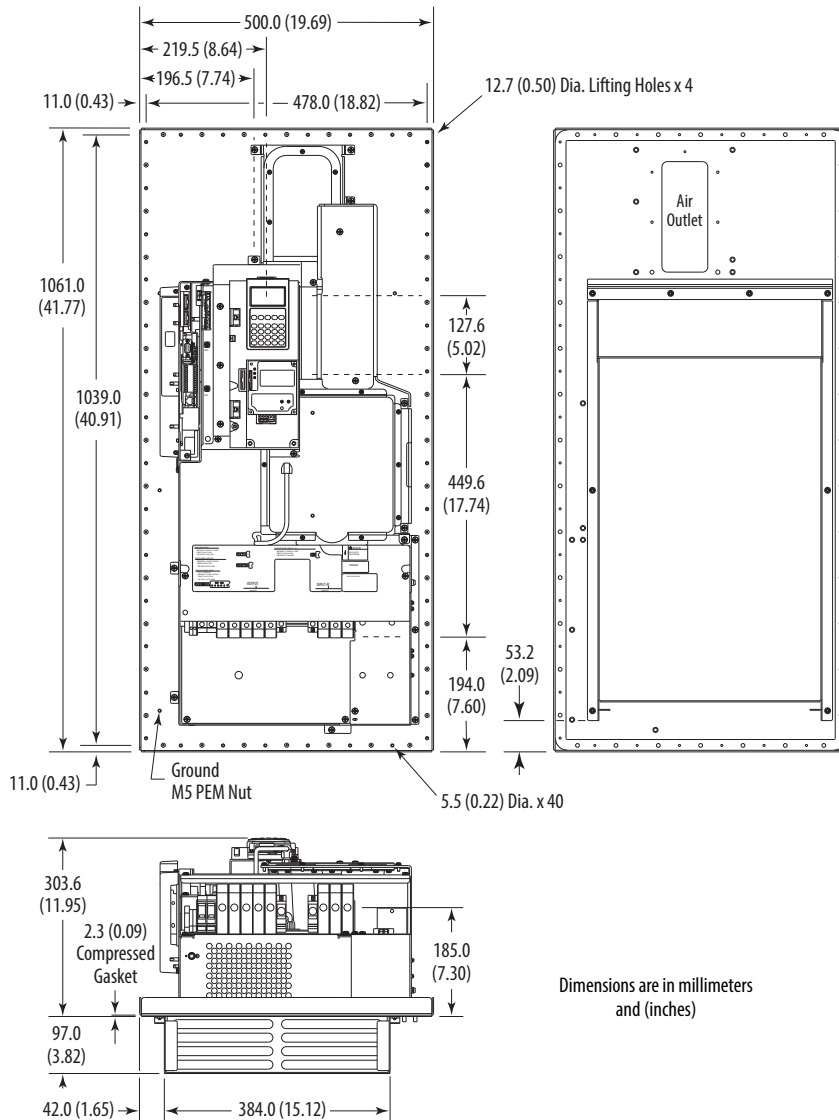

| Frame | Description | Approx. Weight ⁽¹⁾ kg (lbs.) | |
|-------|--------------|---|-------------------|
| | | Drive | Drive & Packaging |
| 5 | Flange Mount | 61.69 (136.0) | 81.65 (180.0) |

(1) Weights include HIM and Standard I/O.

Frame 5 – Flange Mount Cutout

4.00 (0.157) Dia. x 40, minimum 14
 GA. (1.9) steel mounting surface.
 Deburr Pilot Holes and Drive Cutout.

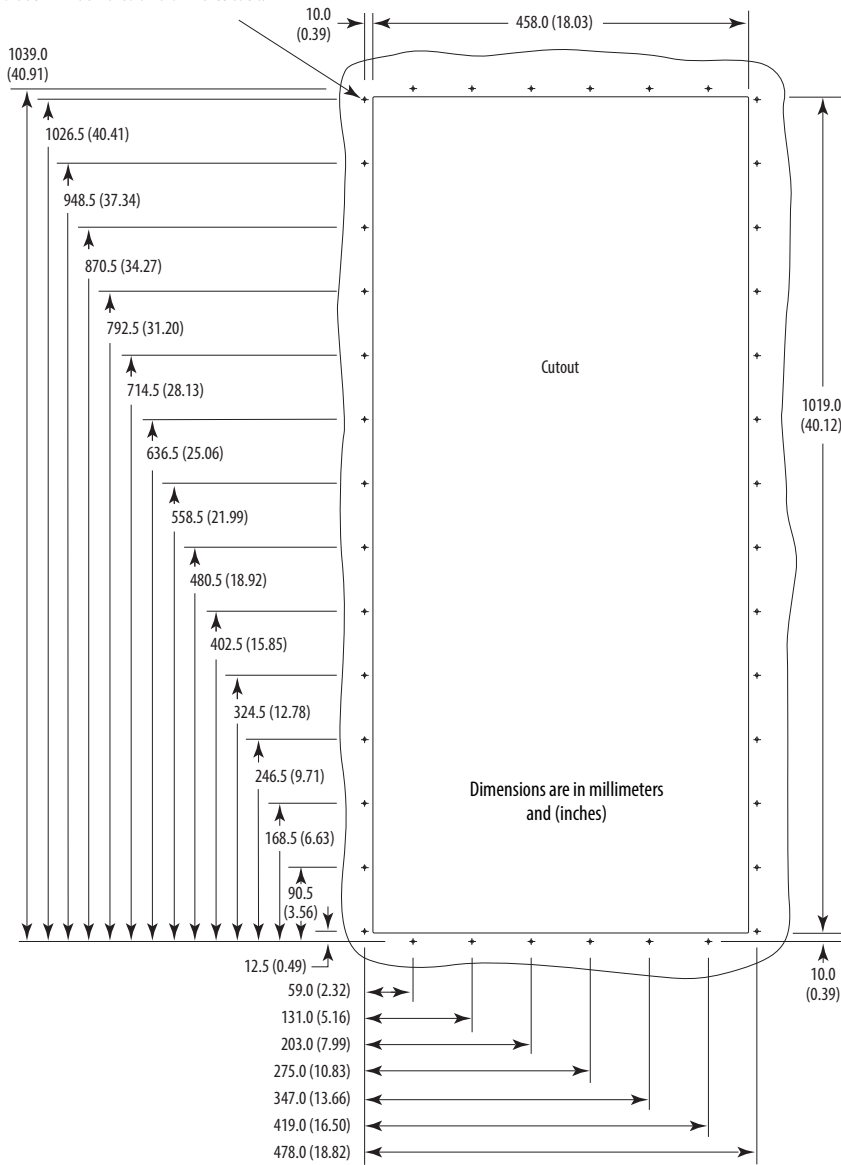

Frame 6 – IP20, NEMA/UL Type 1

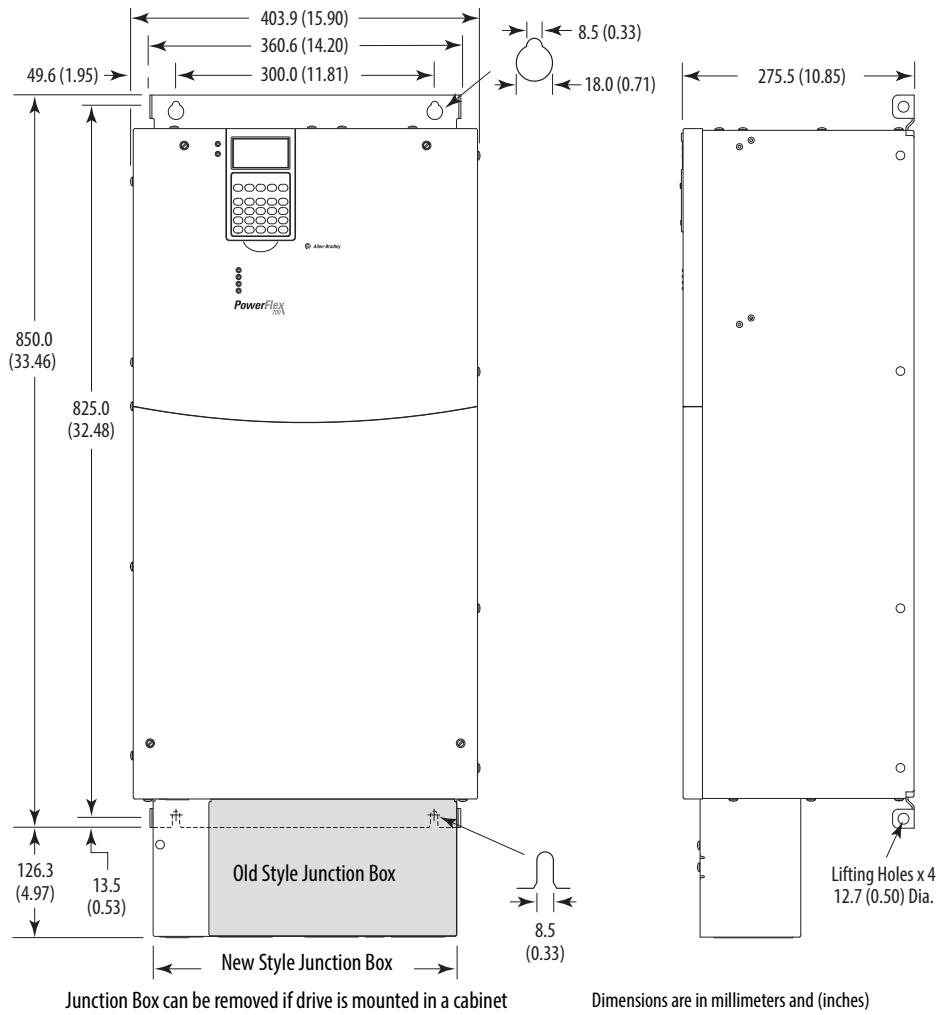

| Frame | Approx. Weight ⁽¹⁾ kg (lbs.) | |
|-------|---|-------------------|
| | Drive | Drive & Packaging |
| 6 | 71.44 (157.5) | 100.9 (222.0) |

(1) Weights include HIM and Standard I/O. Add 13.60 kg (30.0 lbs.) for: 20BB260, 20BC260 and 20BD248.

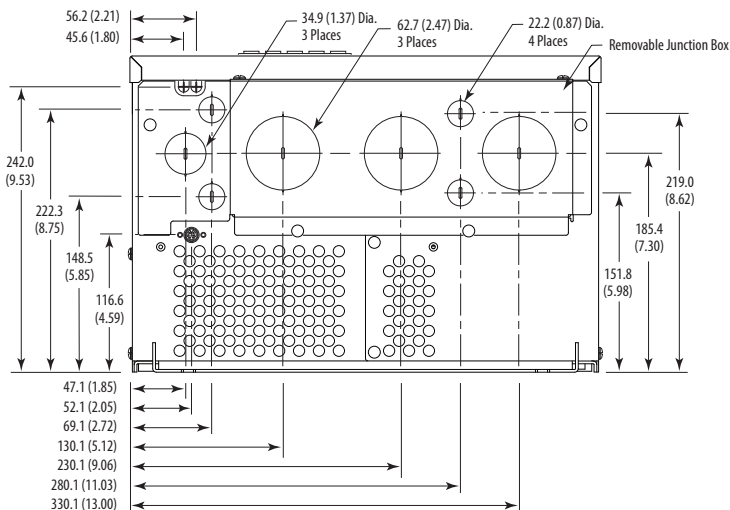

Frame 6 – IP54, NEMA Type 12 Standalone (400...690V drives only)

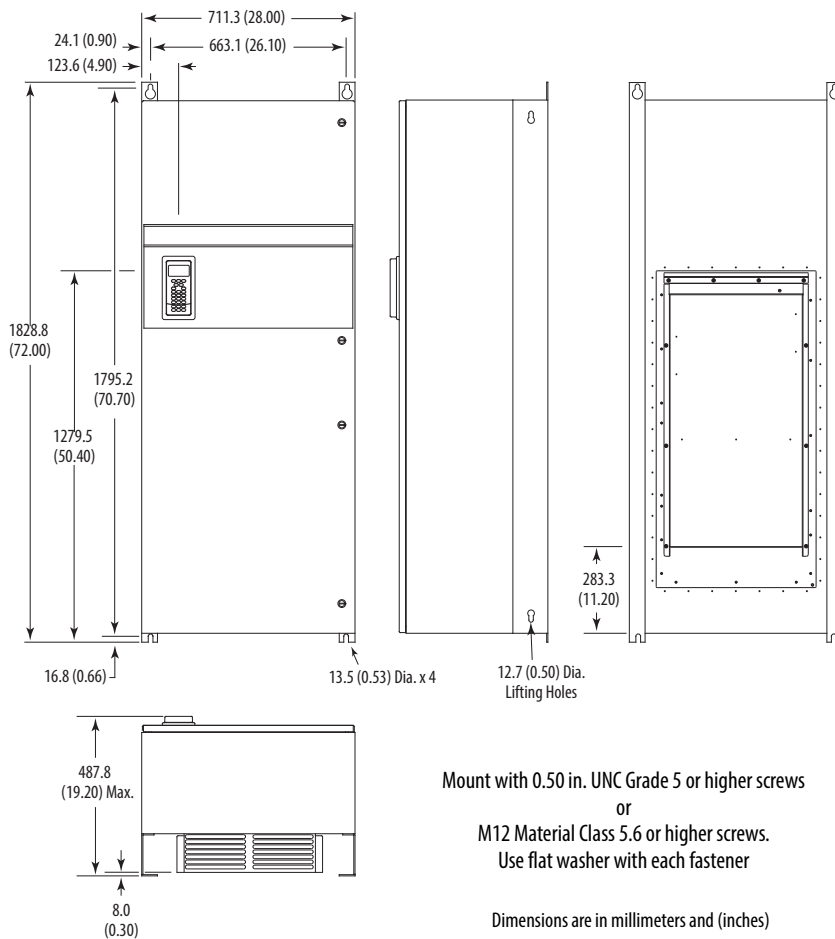

| Frame | Description | Approx. Weight ⁽¹⁾ kg (lbs.) | |
|-------|-------------|---|-------------------|
| | | Drive | Drive & Packaging |
| 6 | Standalone | 176.90 (390.0) | 229.07 (505.0) |

(1) Weights include HIM and Standard I/O.

Frame 6 – IP54, NEMA Type 12 Flange Mount (400...690V drives only)

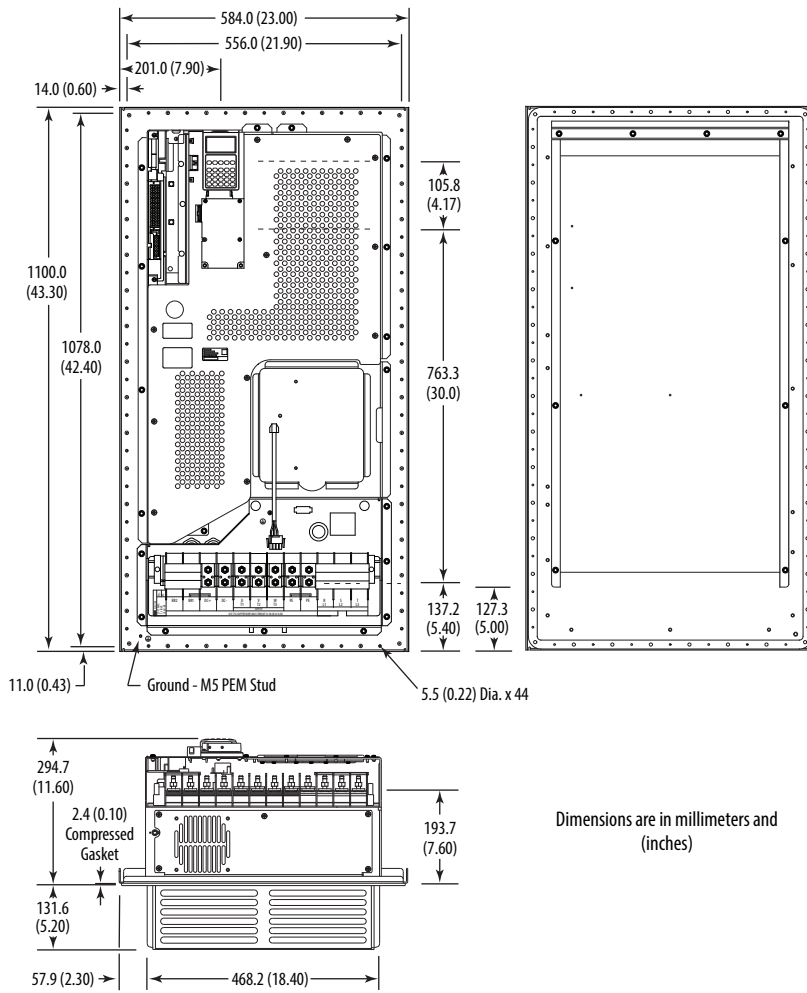

| Frame | Description | Approx. Weight ⁽¹⁾ kg (lbs.) | |
|-------|--------------|---|-------------------|
| | | Drive | Drive & Packaging |
| 6 | Flange Mount | 99.79 (220.0) | 119.75 (264.0) |

(1) Weights include HIM and Standard I/O.

Frame 7 – IP20, NEMA/UL Type 1

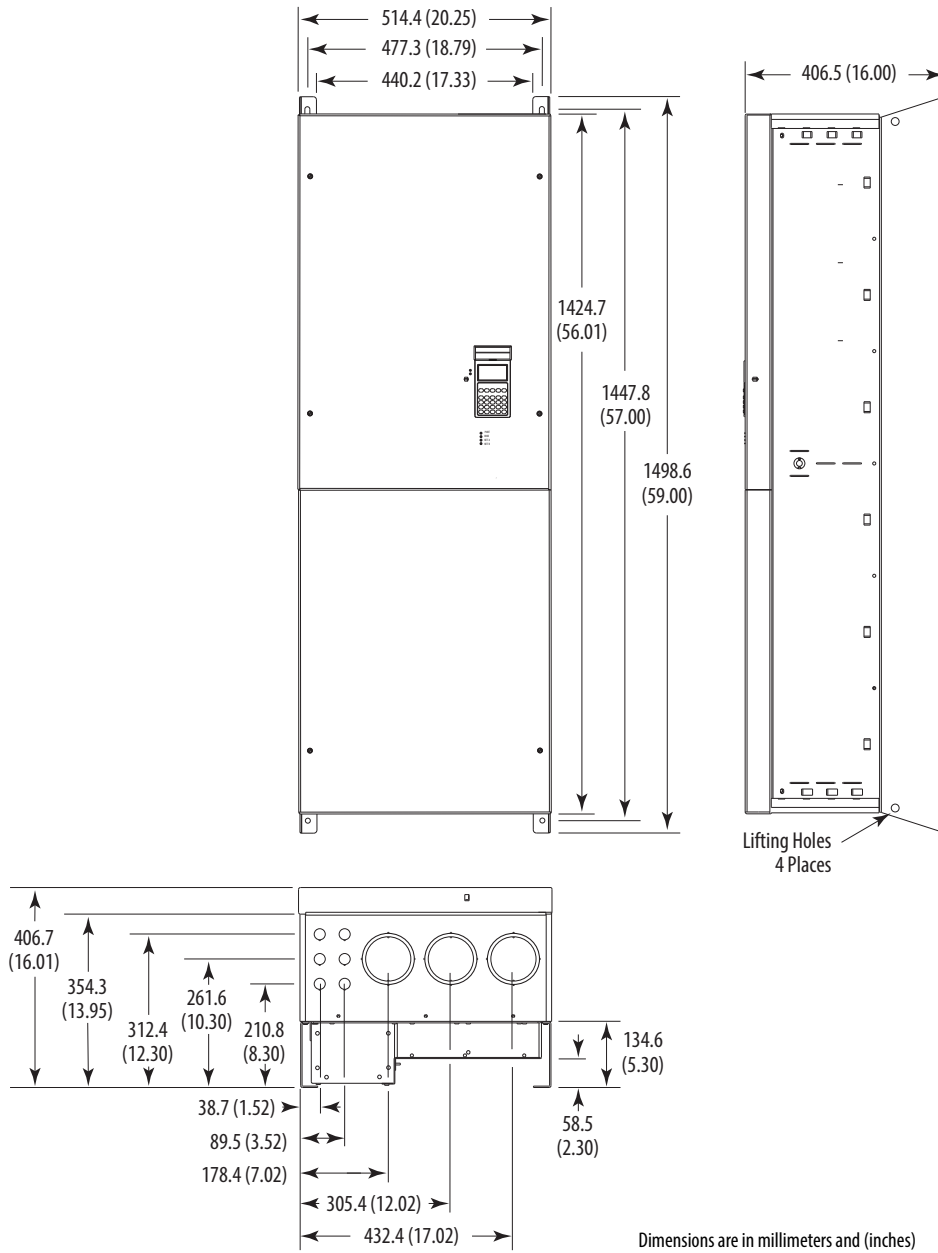

| Approx. Weight kg (lbs.) | |
|--------------------------|-------------------|
| Drive | Drive & Packaging |
| 170 (375) | 196 (433) |

Frame 7 – IP00, NEMA/UL Type Open

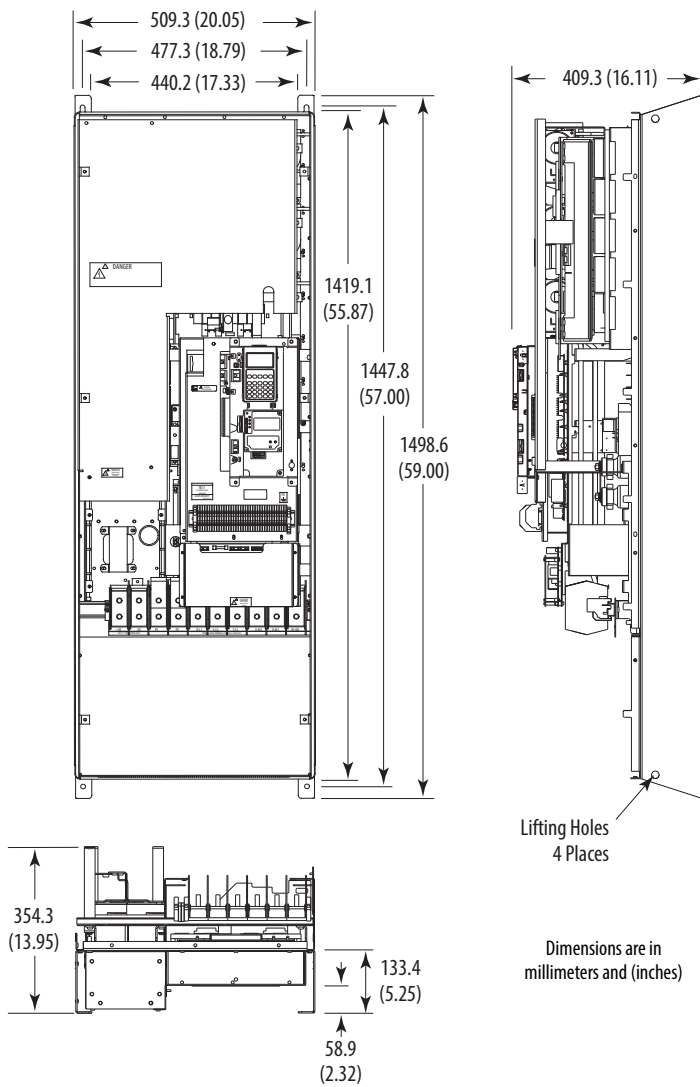

Approx. Weight kg (lbs.)

| Drive | Drive & Packaging |
|-----------|-------------------|
| 147 (324) | 173 (382) |

Frame 7 – Flange Mount Cutout

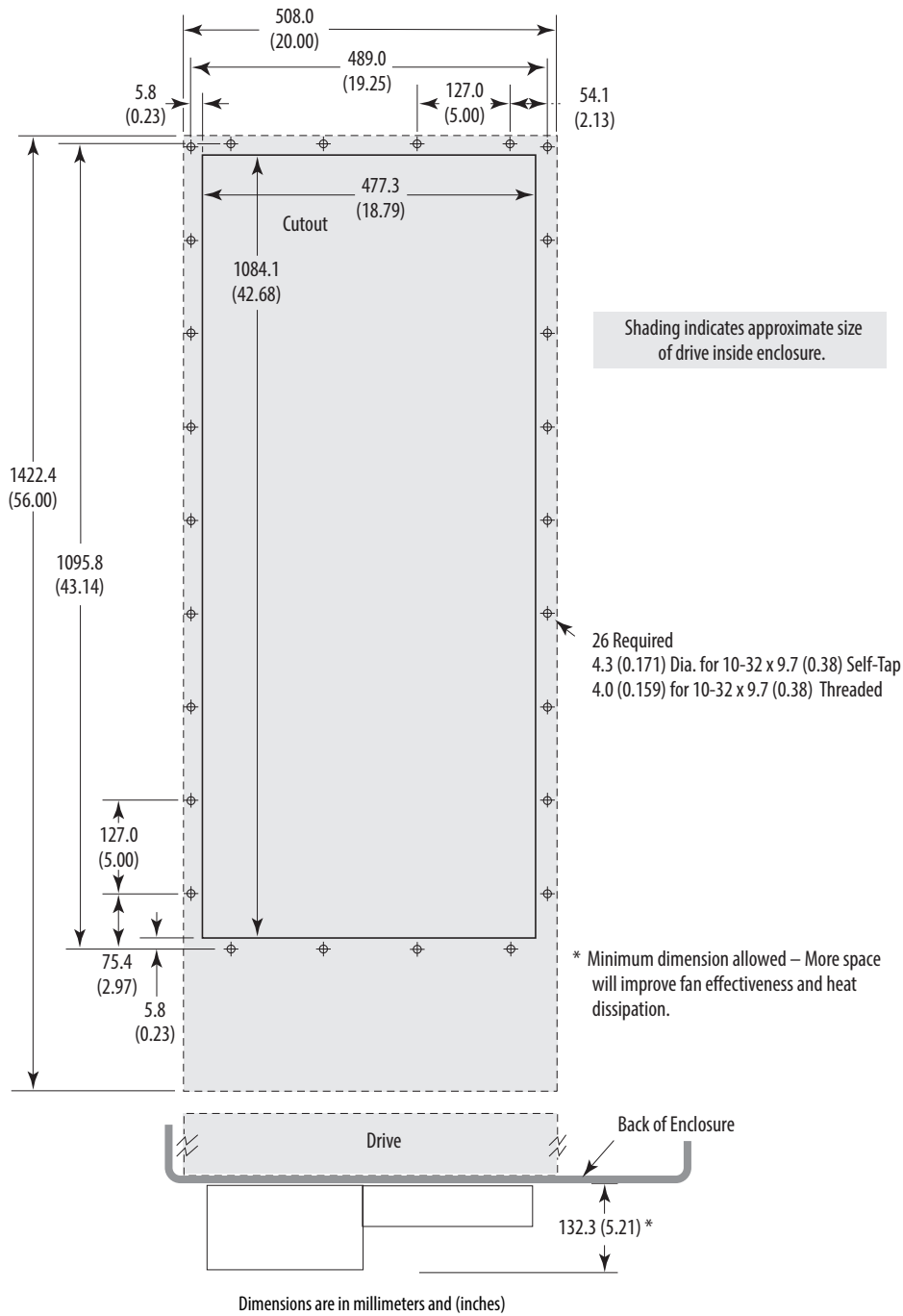

IMPORTANT Use gasket kit catalog number SK-G1-GASKET1-F7 with user supplied IP54, NEMA/UL Type 12 enclosure.

Frames 8...9 – IP20, NEMA/UL Type 1

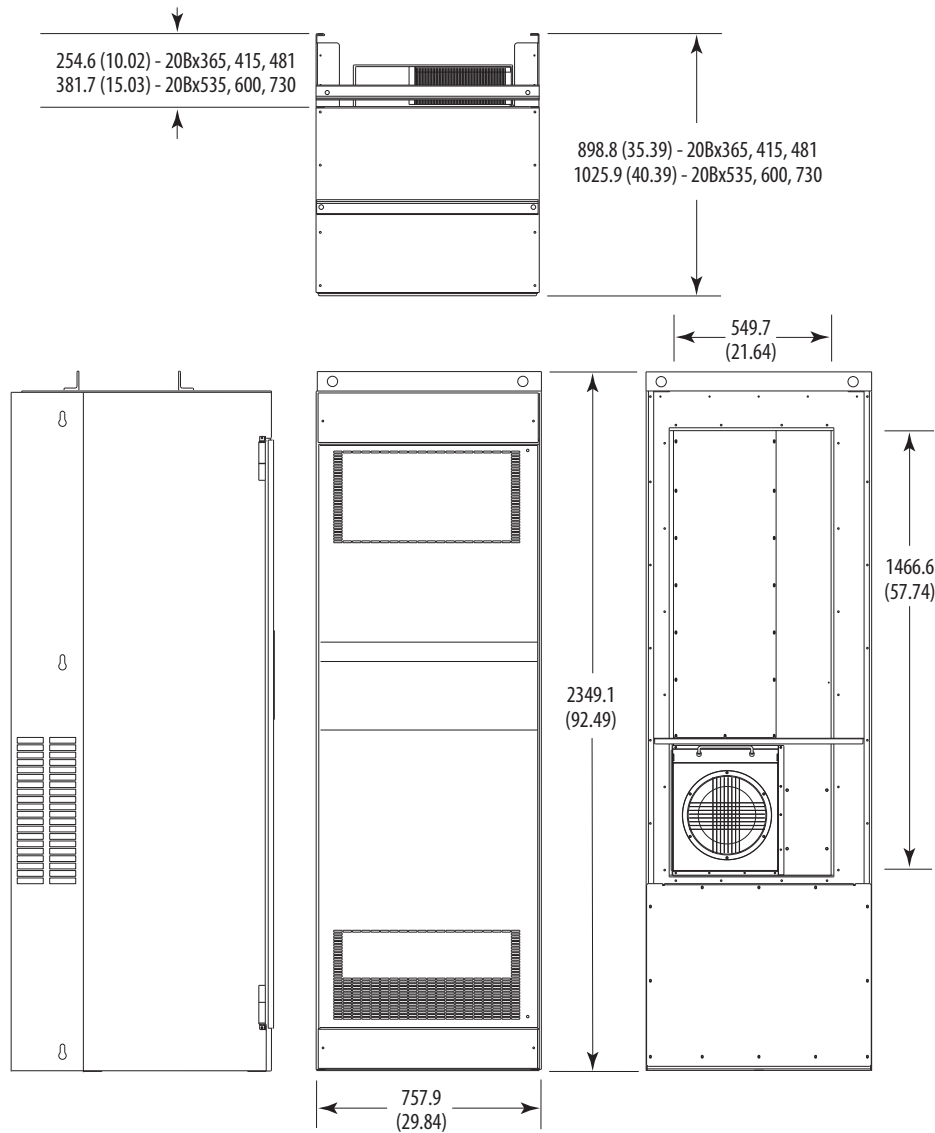

Dimensions are in millimeters and (inches)

| Approx. Weight kg (lbs.) | | |
|--------------------------|------------|-------------------|
| Frame | Drive | Drive & Packaging |
| 8 | 509 (1122) | 556 (1225) |
| 9 | 526 (1159) | 603 (1262) |

Frames 8...9 – IP00, NEMA/UL Type Open

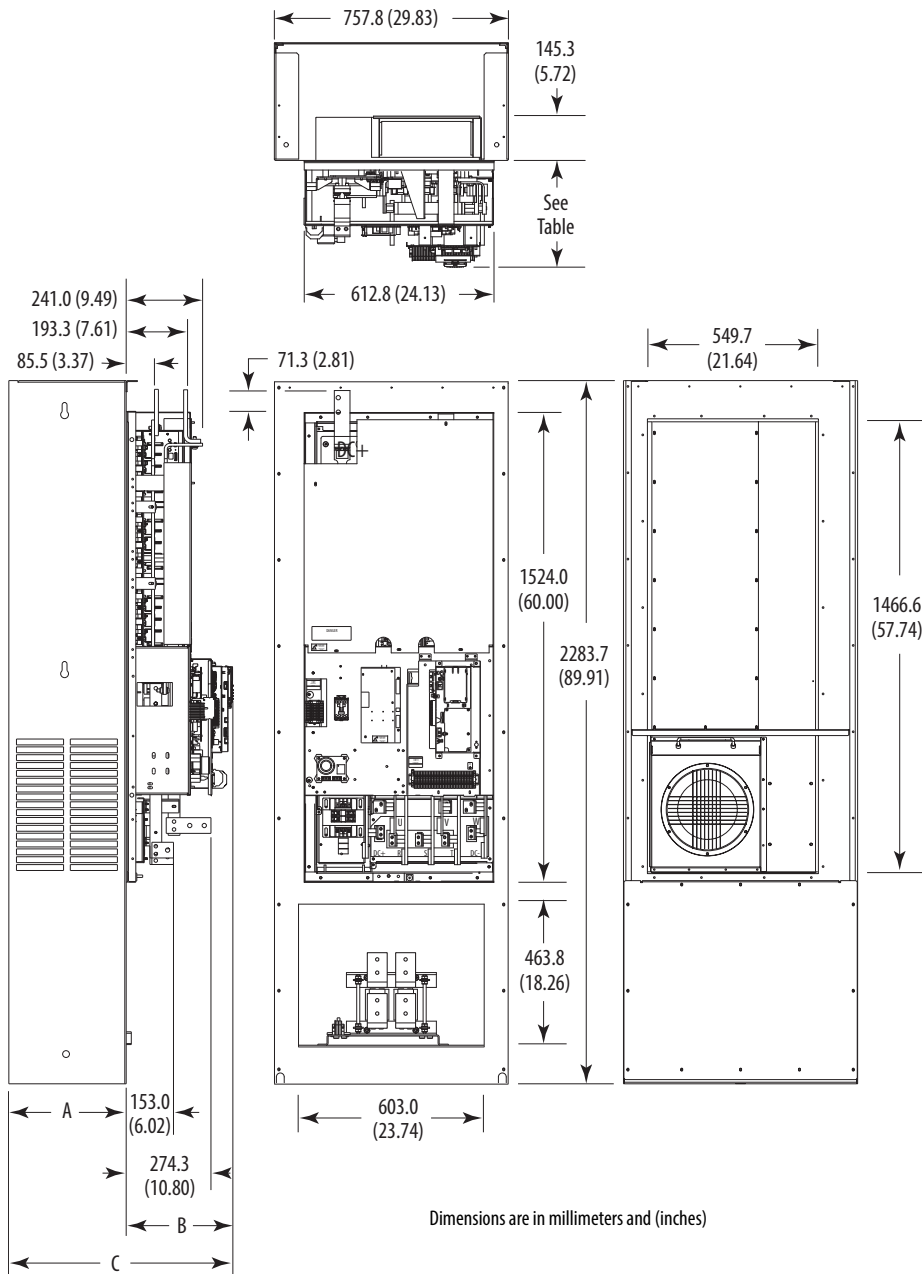

| Frame | Cat. No. | A | B | C | Approx. Weight kg (lbs.) | |
|-------|-------------------|---------------|---------------|---------------|--------------------------|-------------------|
| | | | | | Drive | Drive & Packaging |
| 8 | 20Bx365, 415, 481 | 254.6 (10.02) | 345.3 (13.59) | 599.4 (23.60) | 384 (847) | 431 (950) |
| | 20Bx535, 600 | 381.7 (15.03) | 345.5 (13.60) | 726.6 (28.61) | 384 (847) | 431 (950) |
| 9 | 20Bx730 | 381.1 (15.00) | 345.3 (13.60) | 771.9 (30.39) | 401 (884) | 448 (987) |

Frames 8...9 – Converting an IP00 Drive for Flange Mounting

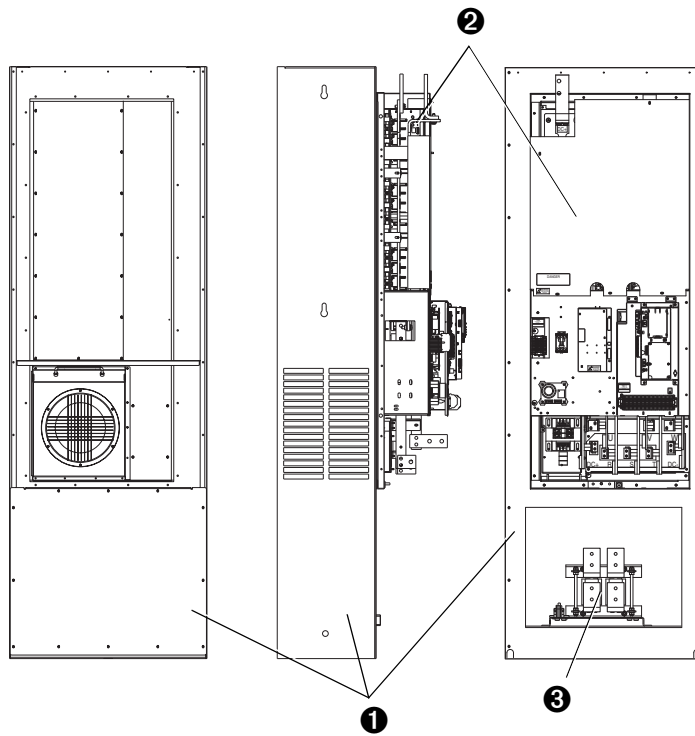

| No. | Component |
|-----|---|
| 1 | Remove these IP00 enclosure components. |
| 2 | Drive assembly to be flange mounted. |
| 3 | DC link choke - mounts separately in enclosure (see page 72 for dimensions) and is wired directly to drive. |

Frames 8...9 Roll-In – IP00, NEMA/UL Type Open

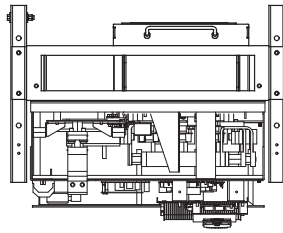

Dimensions are in millimeters and (inches)

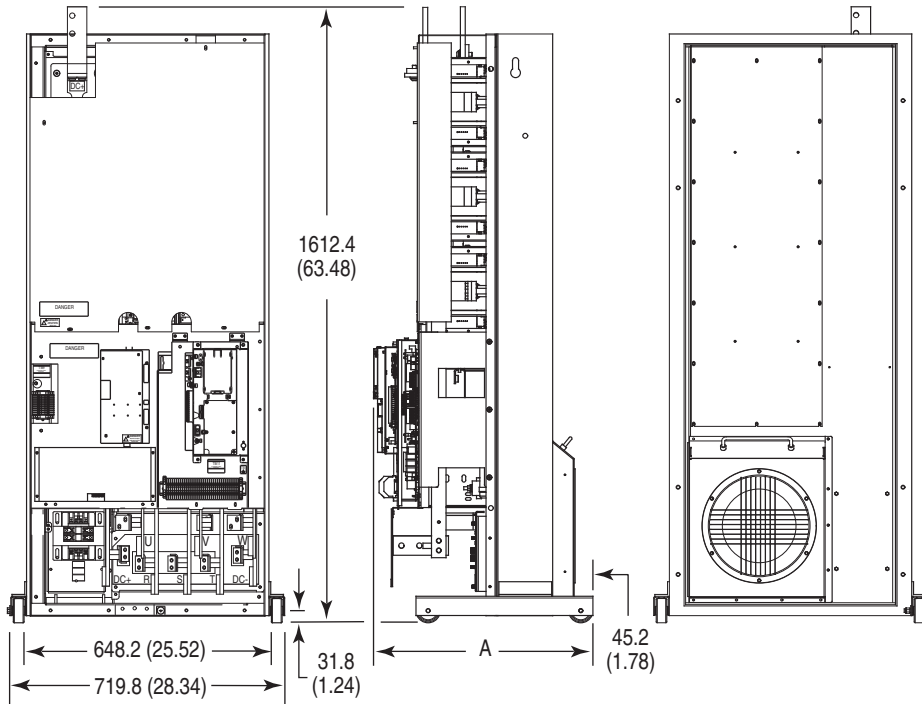

| Frame | Cat. No. | A | Approx. Weight kg (lbs.) | |
|-------|-------------------|---------------|--------------------------|-------------------|
| | | | Drive | Drive & Packaging |
| 8 | 20Bx365, 415, 481 | 574.8 (22.63) | 250 (552) | 297 (655) |
| 8 | 20Bx535, 600 | 574.8 (22.63) | 250 (552) | 297 (655) |
| 9 | 20Bx730 | 594.3 (23.40) | 267 (589) | 314 (692) |

Frames 8...9 Roll-In Mounting Considerations

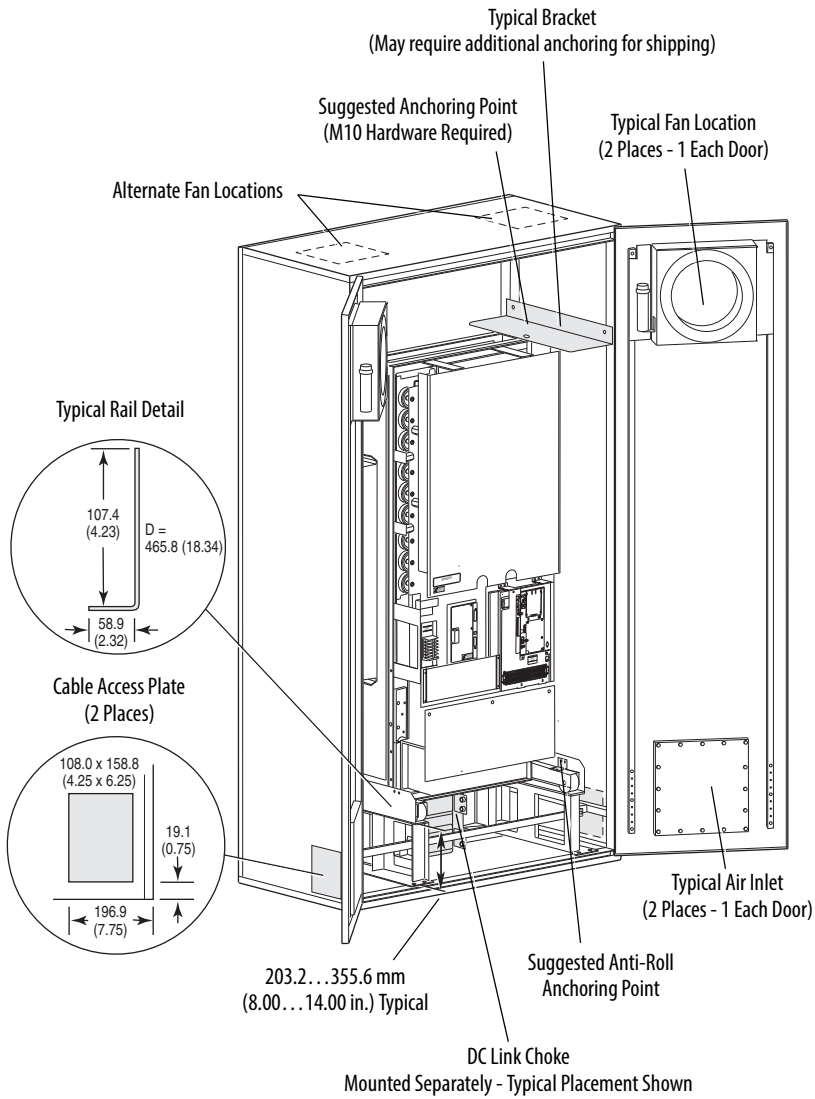

IMPORTANT This information illustrates how an open roll-in style drive could be mounted in a user supplied enclosure. Illustrations are intended only to identify structural mounting points and hardware shapes. You must design and fabricate steel components based on the actual mounting configuration, calculated loads and enclosure specifications. Minimum thickness of all parts = 4.6 mm (0.18 in.).

Frames 8...9 Flange Mount Cutout

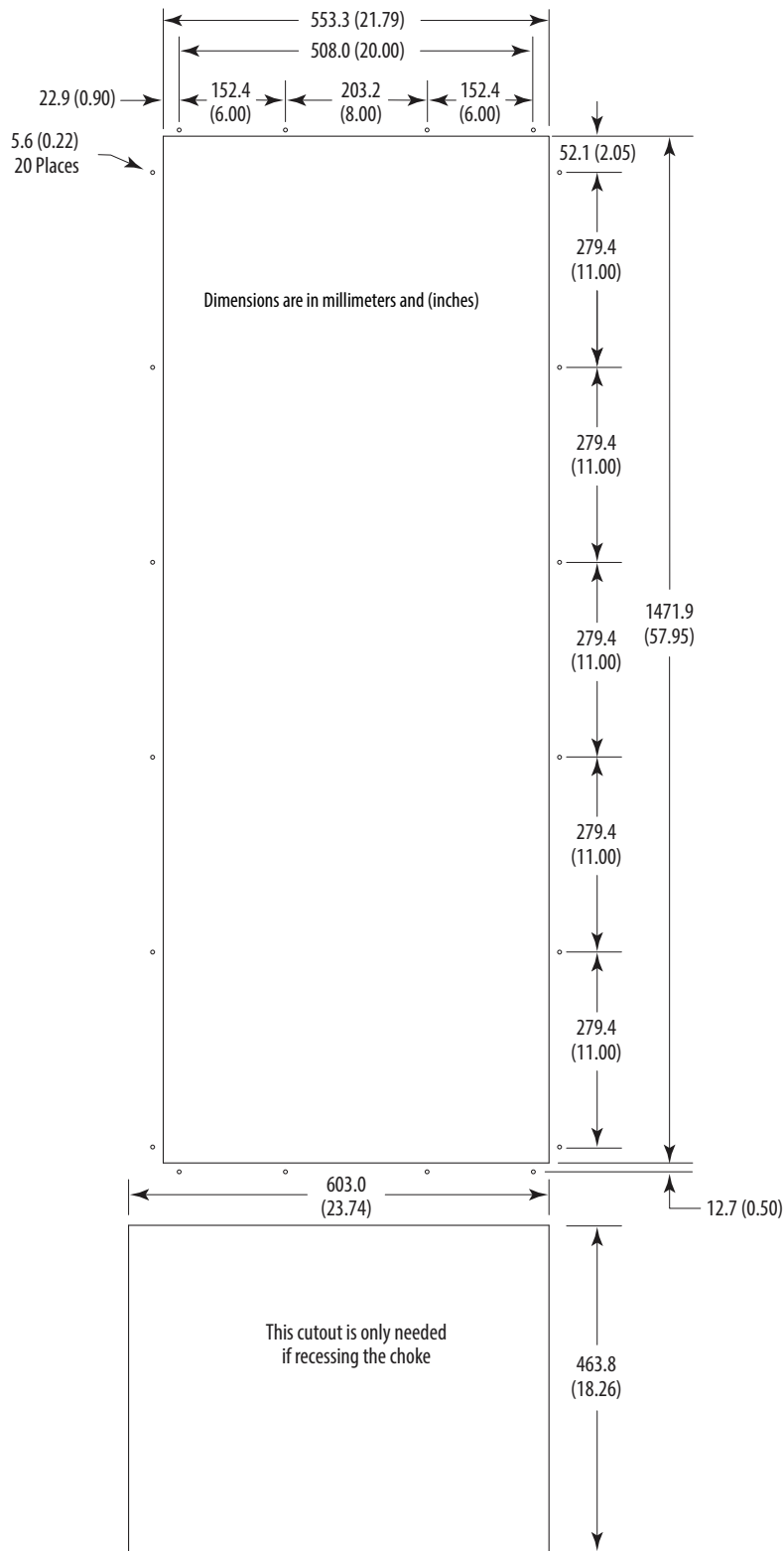

IMPORTANT Use gasket kit catalog number SK-G1-GASKET1-F89 with user supplied IP54, NEMA/UL Type 12 enclosure.

DC Link Chokes

Frame 8

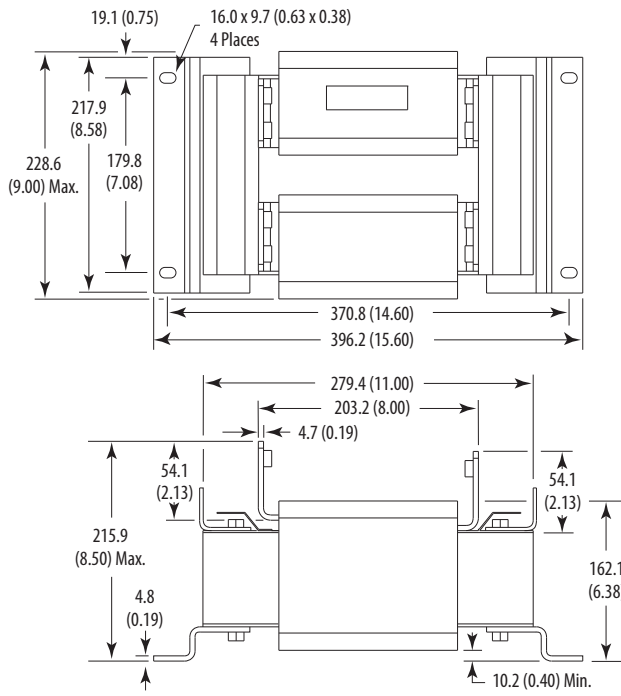

Frame 9

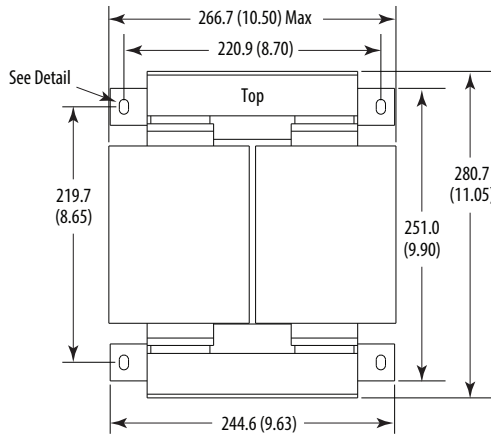
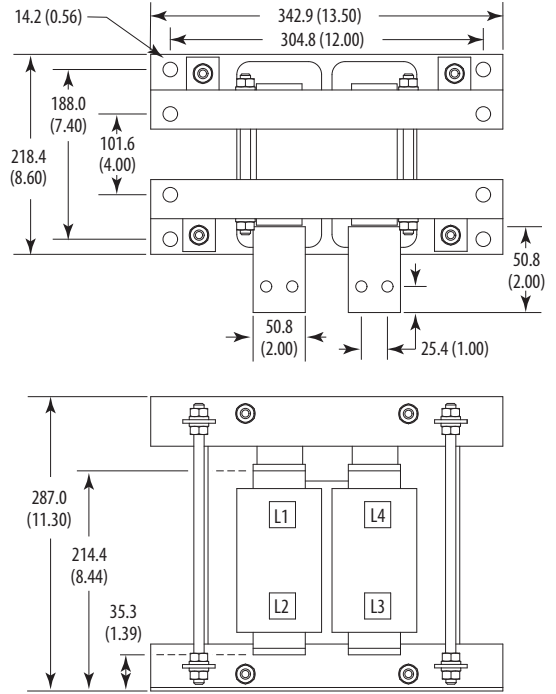

Frame 10

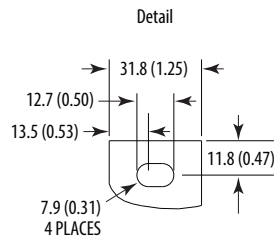

Dimensions are in millimeters and (inches)

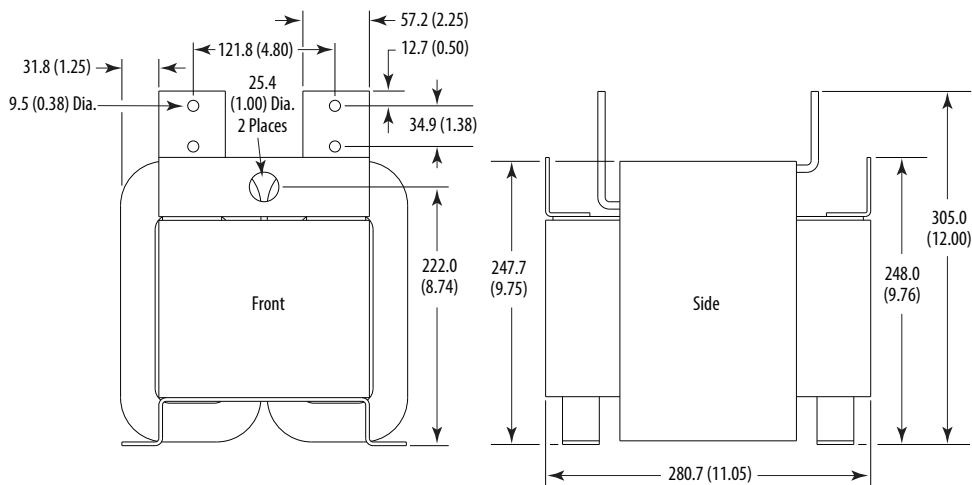

Frame 10 – IP20, NEMA/UL Type 1

AC Input Shown, for DC Input Dimensions use the Inverter (Left) Bay

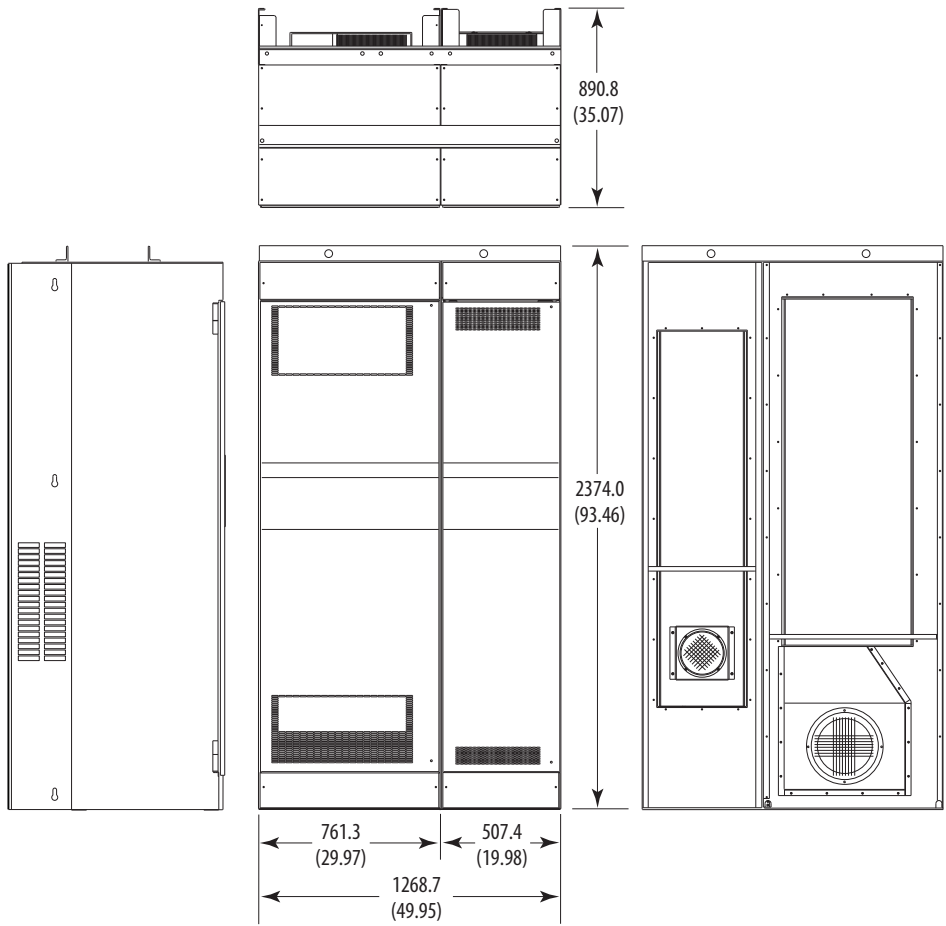

Dimensions are in millimeters and (inches)

| Approx. Weight kg (lbs.) | | |
|--------------------------|------------|-------------------|
| Type | Drive | Drive & Packaging |
| DC Input | 468 (1032) | 515 (1135) |
| AC Input | 867 (1912) | 958 (2112) |

Frame 10 – IP00, NEMA/UL Type Open

AC Input Shown, for DC Input Dimensions use the Inverter (Left) Bay

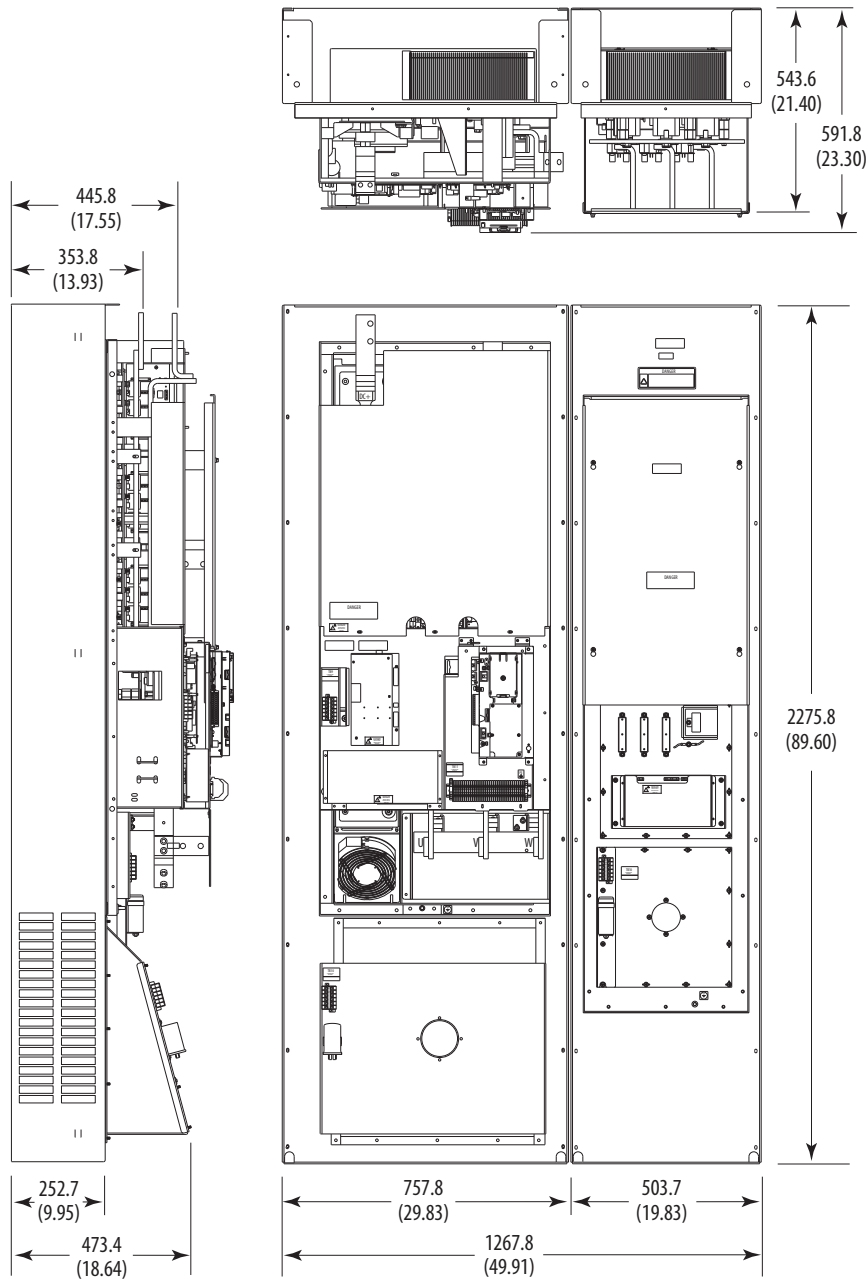

Dimensions are in millimeters and (inches)

Approx. Weight kg (lbs.)

| Type | Drive | Drive & Packaging |
|----------|------------|-------------------|
| DC Input | 305 (672) | 352 (775) |
| AC Input | 532 (1172) | 623 (1372) |

Frame 10 – Flange Mount Cutout

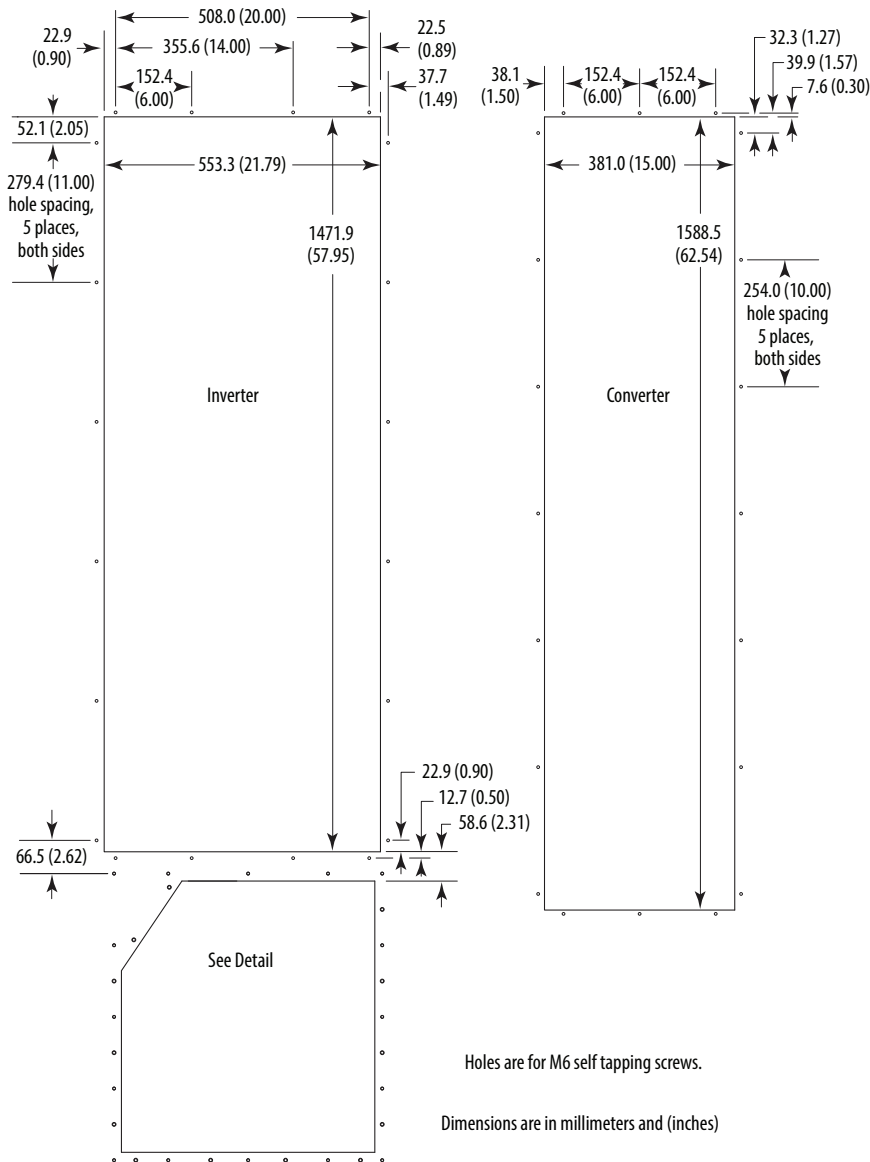

IMPORTANT Backplate and extension are a single piece. Drive chassis can be removed from backplate to mount in user supplied IP54, NEMA/UL Type 12 enclosure.

Frame 10 – Flange Mount Cutout Detail

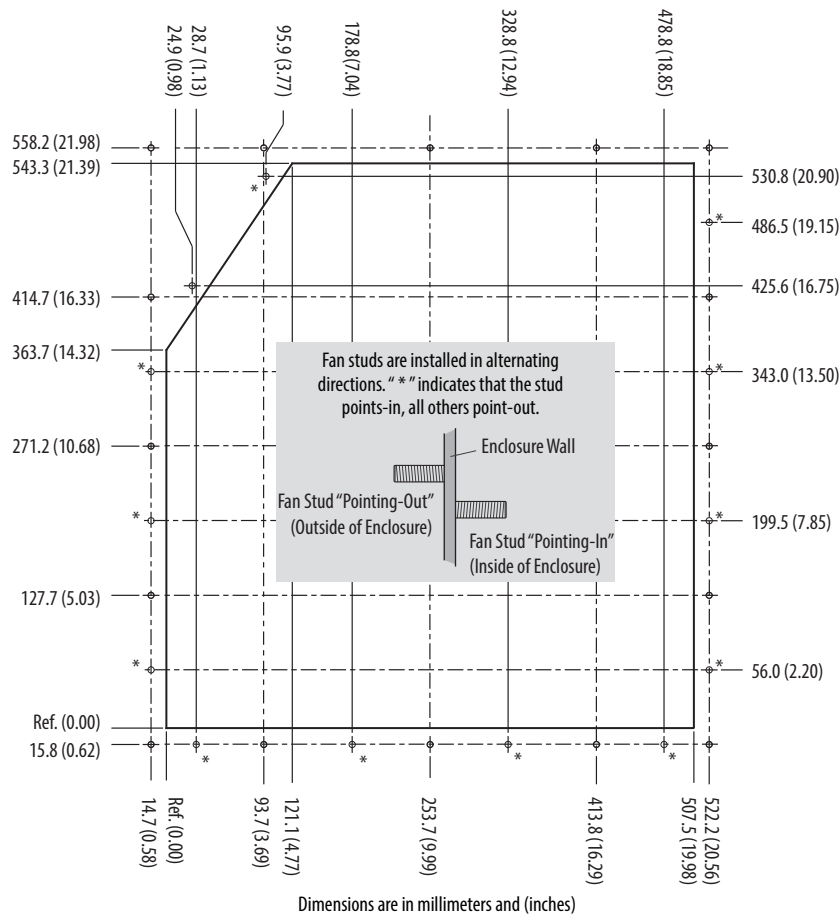

IMPORTANT Backplate and extension are a single piece. Drive chassis can be removed from backplate to mount in user supplied IP54, NEMA/UL Type 12 enclosure.

PowerFlex 700 Packaged Drives

Product Description

PowerFlex 700 Packaged Drives are ideal for global Original Equipment Manufacturers (OEM) and end users with special installation needs. This program simplifies installation and start-up by allowing users to order drive packages that combine operator interface, control, communications and power options in pre-configured assemblies. Designed to meet customer demands for space savings, application flexibility and reliability, Packaged PowerFlex 700 AC drives offer a number of commonly requested pre-engineered options, as well as more complex custom-engineered packages.

Benefits

- Simplified installation and start-up by use of common options assembled at the factory.
- Drive functionality exceeds options offered with a standard drive.
- Multiple packaging options specific to customer needs.
- Pre-engineered options for easy order entry, consistent manufacturing, high quality and reduced deliveries.
- Selectable configurations to meet application requirements.

Features

- Standard PowerFlex 700 AC drives and drive-related options.
- Six pulse and multi-pulse.
- Tuned harmonic filters.
- Enclosure options: Type 1, Type 12 (fan and filter or convection/AC), and Type 4 (indoor).
- Pre-engineered options.
- Custom/engineered solutions.
- UL panel recognition from the factory for pre-engineered options.

Options

- Drive Input Protection
- Input/Output Contactors
- Input/Output Line Reactors
- Bypass
- Control Power
- Control Interface and Feedback
- Communication
- Human Interface Module (HIM)
- Motor Interface
- Door Mounted Operator Devices

Please contact your local distributor or sales office for product availability.

Drive Options

Human Interface Modules



| Description | Cat. No. |
|--|------------|
| No HIM (Blank Plate), Handheld/Local (Drive Mount) | 20-HIM-A0 |
| LCD Display, Full Numeric Keypad, Handheld/Local (Drive Mount) | 20-HIM-A3 |
| Enhanced, LCD, Full Numeric Keypad, Handheld/Local (Drive Mount) | 20-HIM-A6 |
| Remote (Panel Mount) LCD Display, Full Numeric Keypad ⁽¹⁾ (2) | 20-HIM-C3S |
| Enhanced, LCD, Full Numeric Keypad ?‡ | 20-HIM-C6S |

- (1) IP66, NEMA Type 4X/12 - For indoor use only.
- (2) Includes a 1202-C30 interface cable (3 meters) for connection to drive.

Human Interface Module Accessories

| Description | Cat. No. |
|--|-------------------|
| Bezel Kit for LCD HIMs, NEMA Type 1 ⁽¹⁾ | 20-HIM-B1 |
| PowerFlex HIM Interface Cable, 1 m (39 in) ⁽²⁾ | 20-HIM-H10 |
| Comm Option Cable Kit (Male-Male) | |
| 0.33 Meters (1.1 Feet) | 1202-C03 |
| 1 Meter (3.3 Feet) | 1202-C10 |
| 3 Meter (9.8 Feet) | 1202-C30 |
| 9 Meter (29.5 Feet) | 1202-C90 |
| Cable Kit (Male-Female) ⁽³⁾ | |
| 0.33 Meters (1.1 Feet) | 1202-H03 |
| 1 Meter (3.3 Feet) | 1202-H10 |
| 3 Meter (9.8 Feet) | 1202-H30 |
| 9 Meter (29.5 Feet) | 1202-H90 |
| DPI Cable Kit with Connectors, Tools and 100 m (328 ft.) Cable | 1202-CBL-KIT-100M |
| DPI Cable Connector Kit | 1202-TB-KIT-SET |
| DPI/SCANport™ One toTwo Port Splitter Cable | 1203-S03 |

- (1) Includes a 1202-C30 interface cable (3 meters) for connection to drive.
- (2) Required only when HIM is used as handheld or remote.
- (3) Required in addition to 20-HIM-H10 for distances up to a total maximum of 10 Meters (32.8 Feet).

Communication Option Kits and Accessories

| Description | Cat. No. |
|--|---------------------------|
| BACnet® MS/TP RS485 Communication Adapter | 20-COMM-B |
| ControlNet Communication Adapter (Coax) | 20-COMM-C |
| DeviceNet Communication Adapter | 20-COMM-D |
| EtherNet/IP™ Communication Adapter | 20-COMM-E |
| Dual-port EtherNet/IP™ Communication Adapter | 20-COMM-ER ⁽²⁾ |
| HVAC Communication Adapter (Only Modbus RTU can be used) | 20-COMM-H |
| CANopen® Communication Adapter | 20-COMM-K |
| LonWorks® Communication Adapter | 20-COMM-L |
| Modbus/TCP Communication Adapter | 20-COMM-M |
| PROFIBUS™ DP Communication Adapter | 20-COMM-P |
| ControlNet Communication Adapter (Fiber) | 20-COMM-Q |
| Remote I/O Communication Adapter | 20-COMM-R ⁽³⁾ |
| RS485 DF1 Communication Adapter | 20-COMM-S |
| External Communications Kit Power Supply | 20-XCOMM-AC-PS1 |
| DPI External Communications Kit | 20-XCOMM-DC-BASE |
| External DPI I/O Option Board ⁽¹⁾ | 20-XCOMM-IO-OPT1 |
| Compact I/O™ Module (3 Channel) | 1769-SM1 |
| Serial Null Modem Adapter | 1203-SNM |
| Smart Self-powered Serial Converter (RS232) includes 1203-SFC and 1202-C10 Cables | 1203-S5S |
| Universal Serial Bus™ (USB) Converter includes 2 m USB, 20-HIM-H10 & 22-HIM-H10 Cables | 1203-USB |

(1) For use only with DPI External Communications Kits 20-XCOMM-DC-BASE.

(2) Contact your local Rockwell Automation sales office or Allen-Bradley distributor for availability.

(3) This item has Silver Series status. For information, refer to <http://www.ab.com/silver>.

Feedback Options

| Description | Cat. No. |
|-------------------------------|-----------|
| 12V/5V Encoder ⁽¹⁾ | 20B-ENC-1 |

(1) Vector Control only.

Other Options

| Description | Cat. No. |
|----------------------------------|----------------|
| Removable I/O Terminal Block | SK-G9-TB1-S1 |
| Removable Encoder Terminal Block | SK-G9-TB1-ENC1 |

PowerFlex 700 Control Option Kits

| Control with I/O | Factory Installed Cat. Code # ⁽²⁾ | Cat. No. |
|---|--|----------------|
| Vector Control - 24V DC with: ⁽¹⁾ | | |
| 60 Hz Maximum | NNAD | 20B-VECT-COAD |
| 82 Hz Maximum | NNAX | 20B-VECTB-COAX |
| Cascading Fan/Pump Control | NNAE | 20B-VECT-COAE |
| Pump Off (for Pump Jack) | NNBA | 20B-VECTB-COBA |
| Vector Control - 115V AC ⁽¹⁾ | | |
| Vector Control - 115V AC with: ⁽¹⁾ | | |
| 60 Hz Maximum | NNAD | 20B-VECT-DOAD |
| 82 Hz Maximum | NNAX | 20B-VECTB-DOAX |
| Cascading Fan/Pump Control | NNAE | 20B-VECT-DOAE |
| Pump Off (for Pump Jack) | NNBA | 20B-VECT-DOBA |

(1) Vector Control option utilizes DPI Only.

(2) This code is entered at the end of the drive catalog number (positions 17...20).

(3) This code is entered at position 15 of the drive catalog number.

Internal Dynamic Brake Resistor Kits

These resistors have a limited duty cycle. Refer to the PowerFlex Dynamic Braking Selection Guide to determine if an internal resistor will be sufficient for your application. An external resistor may be required.

| Drive Input Voltage | Brake Resistance | Frame | Cat. No. |
|---------------------|------------------|-------------------|------------|
| | Ohms | | |
| 208...240V AC | 62 | 0 | 20BB-DB1-0 |
| | 62 | 1 (except 7.5 Hp) | 20BB-DB1-1 |
| | 22 | 1 (7.5 Hp) | 20BB-DB2-1 |
| | 22 | 2 | 20BB-DB1-2 |
| 380...600V AC | 115 | 0 | 20BD-DB1-0 |
| | 115 | 1 | 20BD-DB1-1 |
| | 68 | 2 | 20BD-DB1-2 |

Terminators

| Description ⁽¹⁾ | Cat. No. |
|---|-----------|
| for use with 3.7 kW (5 Hp) & below drives | 1204-TFA1 |
| for use with 1.5 kW (2 Hp) & up drives | 1204-TFB2 |

(1) Refer to Appendix A of the Wiring and Grounding Guidelines for Pulse Width Modulated (PWM) AC Drives, publication [Drives-INO01](#) for selection information.

Reflected Wave Reduction Modules w/Common Mode Choke

| Description ⁽¹⁾ | Cat. No. |
|----------------------------|---------------|
| 17A with Common Mode Choke | 1204-RWC-17-A |

(1) Refer to Appendix A of the Wiring and Grounding Guidelines for Pulse Width Modulated (PWM) AC Drives, publication [Drives-INO01](#) for selection information.

Isolation Transformers

For installations that have specific types of AC supply configurations or require drive protection due to AC line disturbances, isolation transformers are available.

IP32 (NEMA/UL Type 3R)

| Motor Rating kW (Hp) | 240V, 60 Hz, Three-Phase, 240V Primary & 240V Secondary | 460V, 60 Hz, Three-Phase, 460V Primary & 460V Secondary | 575V, 60 Hz, Three-Phase, 575V Primary & 575V Secondary |
|-------------------------|--|--|--|
| | Cat. No. | Cat. No. | Cat. No. |
| 0.25 (0.33) | 1321-3TW005-AA | 1321-3TW005-BB | – |
| 0.37 (0.5) | 1321-3TW005-AA | 1321-3TW005-BB | – |
| 0.55 (0.75) | 1321-3TW005-AA | 1321-3TW005-BB | – |
| 0.75 (1.0) | 1321-3TW005-AA | 1321-3TW005-BB | 1321-3TW005-CC |
| 1.1 (1.5) | 1321-3TW005-AA | 1321-3TW005-BB | – |
| 1.5 (2.0) | 1321-3TW005-AA | 1321-3TW005-BB | 1321-3TW005-CC |
| 2.2 (3.0) | 1321-3TW005-AA | 1321-3TW005-BB | 1321-3TW005-CC |
| 4.0 (5.0) | 1321-3TW007-AA | 1321-3TW007-BB | 1321-3TW007-CC |
| 5.5 (7.5) | 1321-3TW011-AA | 1321-3TW011-BB | 1321-3TW011-CC |
| 7.5 (10) | 1321-3TW014-AA | 1321-3TW014-BB | 1321-3TW014-CC |
| 11 (15) | 1321-3TW020-AA | 1321-3TW020-BB | 1321-3TW020-CC |
| 15 (20) | 1321-3TW027-AA | 1321-3TW027-BB | 1321-3TW027-CC |
| 18.5 (25) | 1321-3TW034-AA | 1321-3TW034-BB | 1321-3TW034-CC |
| 22 (30) | 1321-3TW040-AA | 1321-3TW040-BB | 1321-3TW040-CC |
| 30 (40) | 1321-3TW051-AA | 1321-3TW051-BB | 1321-3TW051-CC |
| 37 (50) | 1321-3TH063-AA | 1321-3TH063-BB | 1321-3TH063-CC |
| 45 (60) | 1321-3TH075-AA | 1321-3TH075-BB | 1321-3TH075-CC |
| 55 (75) | 1321-3TH093-AA | 1321-3TH093-BB | 1321-3TH093-CC |
| 75 (100) | – | 1321-3TH118-BB | 1321-3TH118-CC |
| 90 (125) | – | 1321-3TH145-BB | 1321-3TH145-CC |
| 110 (150) | – | 1321-3TH175-BB | 1321-3TH175-CC |
| 149 (200) | – | 1321-3TH220-BB | 1321-3TH220-CC |
| 187 (250) | – | 1321-3TH275-BB | 1321-3TH275-CC |
| 224 (300) | – | 1321-3TH330-BB | 1321-3TH330-CC |
| 261 (350) | – | 1321-3TH440-BB | 1321-3TH440-CC |
| 298 (400) | – | 1321-3TH440-BB | 1321-3TH440-CC |
| 336 (450) | – | 1321-3TH550-BB | 1321-3TH550-CC |
| 373 (500) | – | 1321-3TH550-BB | 1321-3TH550-CC |
| 448 (600) | – | 1321-3TH660-BB | 1321-3TH660-CC |
| 485 (650) | – | – | 1321-3TH770-CC |
| 522 (700) | – | 1321-3TH770-BB | 1321-3TH770-CC |

Input/Output Line Reactors

For impedance matching, protection from AC line disturbances or motor protection, reactors are available for both the input and output sides of the drive.

240V, 60 Hz, Three-Phase, 3% Impedance

| Drive Cat. No. | Duty | Hp | Input Line Reactor ⁽¹⁾ | | Output Line Reactor ⁽¹⁾ | |
|----------------|-------------|------|-----------------------------------|-----------------------|------------------------------------|-----------------------|
| | | | IP00 (Open Style) | IP11 (NEMA/UL Type 1) | IP00 (Open Style) | IP11 (NEMA/UL Type 1) |
| | | | Cat. No. | Cat. No. | Cat. No. | Cat. No. |
| 20BB2P2 | Heavy Duty | 0.33 | 1321-3R2-D | 1321-3RA2-D | 1321-3R2-D | 1321-3RA2-D |
| 20BB2P2 | Normal Duty | 0.5 | 1321-3R2-D | 1321-3RA2-D | 1321-3R2-D | 1321-3RA2-D |
| 20BB4P2 | Heavy Duty | 0.75 | 1321-3R4-A | 1321-3RA4-A | 1321-3R4-A | 1321-3RA4-A |
| 20BB4P2 | Normal Duty | 1 | 1321-3R4-A | 1321-3RA4-A | 1321-3R4-A | 1321-3RA4-A |
| 20BB6P8 | Heavy Duty | 1.5 | 1321-3R8-B | 1321-3RA8-B | 1321-3R8-A | 1321-3RA8-A |
| 20BB6P8 | Normal Duty | 2 | 1321-3R8-A | 1321-3RA8-A | 1321-3R8-A | 1321-3RA8-A |
| 20BB9P6 | Heavy Duty | 2 | 1321-3R8-A | 1321-3RA8-A | 1321-3R12-A | 1321-3RA12-A |
| 20BB9P6 | Normal Duty | 3 | 1321-3R12-A | 1321-3RA12-A | 1321-3R12-A | 1321-3RA12-A |
| 20BB015 | Heavy Duty | 3 | 1321-3R12-A | 1321-3RA12-A | 1321-3R18-A | 1321-3RA18-A |
| 20BB015 | Normal Duty | 5 | 1321-3R18-A | 1321-3RA18-A | 1321-3R18-A | 1321-3RA18-A |
| 20BB022 | Heavy Duty | 5 | 1321-3R18-A | 1321-3RA18-A | 1321-3R25-A | 1321-3RA25-A |
| 20BB022 | Normal Duty | 7.5 | 1321-3R25-A | 1321-3RA25-A | 1321-3R25-A | 1321-3RA25-A |
| 20BB028 | Heavy Duty | 7.5 | 1321-3R25-A | 1321-3RA25-A | 1321-3R35-A | 1321-3RA35-A |
| 20BB028 | Normal Duty | 10 | 1321-3R35-A | 1321-3RA35-A | 1321-3R35-A | 1321-3RA35-A |
| 20BB042 | Heavy Duty | 10 | 1321-3R35-A | 1321-3RA35-A | 1321-3R45-A | 1321-3RA45-A |
| 20BB042 | Normal Duty | 15 | 1321-3R45-A | 1321-3RA45-A | 1321-3R45-A | 1321-3RA45-A |
| 20BB052 | Heavy Duty | 15 | 1321-3R45-A | 1321-3RA45-A | 1321-3R55-A | 1321-3RA55-A |
| 20BB052 | Normal Duty | 20 | 1321-3R55-A | 1321-3RA55-A | 1321-3R55-A | 1321-3RA55-A |
| 20BB070 | Heavy Duty | 20 | 1321-3R55-A | 1321-3RA55-A | 1321-3R80-A | 1321-3RA80-A |
| 20BB070 | Normal Duty | 25 | 1321-3R80-A | 1321-3RA80-A | 1321-3R80-A | 1321-3RA80-A |
| 20BB080 | Heavy Duty | 25 | 1321-3R80-A | 1321-3RA80-A | 1321-3R80-A | 1321-3RA80-A |
| 20BB080 | Normal Duty | 30 | 1321-3R80-A | 1321-3RA80-A | 1321-3R80-A | 1321-3RA80-A |
| 20BB104 | Heavy Duty | 30 | 1321-3R80-A | 1321-3RA80-A | 1321-3R80-A | 1321-3RA80-A |
| 20BB104 | Normal Duty | 40 | 1321-3R100-A | 1321-3RA100-A | 1321-3R100-A | 1321-3RA100-A |
| 20BB130 | Heavy Duty | 40 | 1321-3R100-A | 1321-3RA100-A | 1321-3R100-A | 1321-3RA100-A |
| 20BB130 | Normal Duty | 50 | 1321-3R130-A | 1321-3RA130-A | 1321-3R130-A | 1321-3RA130-A |
| 20BB154 | Heavy Duty | 50 | 1321-3R130-A | 1321-3RA130-A | 1321-3R130-A | 1321-3RA130-A |
| 20BB154 | Normal Duty | 60 | 1321-3R160-A | 1321-3RA160-A | 1321-3R160-A | 1321-3RA160-A |
| 20BB192 | Heavy Duty | 60 | 1321-3R160-A | 1321-3RA160-A | 1321-3R160-A | 1321-3RA160-A |
| 20BB192 | Normal Duty | 75 | 1321-3R200-A | 1321-3RA200-A | 1321-3R200-A | 1321-3RA200-A |
| 20BB260 | Heavy Duty | 75 | 1321-3R200-A | 1321-3RA200-A | 1321-3R200-A | 1321-3RA200-A |
| 20BB260 | Normal Duty | 100 | 1321-3RB250-A | 1321-3RAB250-A | 1321-3RB250-A | 1321-3RAB250-A |

(1) Input line reactors were sized based on the NEC fundamental motor amps. Output line reactors were sized based on the VFD rated output currents.

240V, 60 Hz, Three-Phase, 5% Impedance

| Drive Cat. No. | Duty | Hp | Input Line Reactor ⁽¹⁾ | | Output Line Reactor ⁽¹⁾ | |
|----------------|-------------|------|-----------------------------------|-----------------------|------------------------------------|-----------------------|
| | | | IP00 (Open Style) | IP11 (NEMA/UL Type 1) | IP00 (Open Style) | IP11 (NEMA/UL Type 1) |
| | | | Cat. No. | Cat. No. | Cat. No. | Cat. No. |
| 20BB2P2 | Heavy Duty | 0.33 | 1321-3R2-A | 1321-3RA2-A | 1321-3R2-A | 1321-3RA2-A |
| 20BB2P2 | Normal Duty | 0.5 | 1321-3R2-A | 1321-3RA2-A | 1321-3R2-A | 1321-3RA2-A |
| 20BB4P2 | Heavy Duty | 0.75 | 1321-3R4-B | 1321-3RA4-B | 1321-3R4-B | 1321-3RA4-B |
| 20BB4P2 | Normal Duty | 1 | 1321-3R4-B | 1321-3RA4-B | 1321-3R4-B | 1321-3RA4-B |
| 20BB6P8 | Heavy Duty | 1.5 | 1321-3R8-B | 1321-3RA8-B | 1321-3R8-B | 1321-3RA8-B |
| 20BB6P8 | Normal Duty | 2 | 1321-3R8-B | 1321-3RA8-B | 1321-3R8-B | 1321-3RA8-B |
| 20BB9P6 | Heavy Duty | 2 | 1321-3R8-B | 1321-3RA8-B | 1321-3R12-B | 1321-3RA12-B |
| 20BB9P6 | Normal Duty | 3 | 1321-3R12-B | 1321-3RA12-B | 1321-3R12-B | 1321-3RA12-B |
| 20BB015 | Heavy Duty | 3 | 1321-3R12-B | 1321-3RA12-B | 1321-3R18-B | 1321-3RA18-B |
| 20BB015 | Normal Duty | 5 | 1321-3R18-B | 1321-3RA18-B | 1321-3R18-B | 1321-3RA18-B |
| 20BB022 | Heavy Duty | 5 | 1321-3R18-B | 1321-3RA18-B | 1321-3R25-B | 1321-3RA25-B |
| 20BB022 | Normal Duty | 7.5 | 1321-3R25-B | 1321-3RA25-B | 1321-3R25-B | 1321-3RA25-B |
| 20BB028 | Heavy Duty | 7.5 | 1321-3R25-B | 1321-3RA25-B | 1321-3R35-B | 1321-3RA35-B |
| 20BB028 | Normal Duty | 10 | 1321-3R35-B | 1321-3RA35-B | 1321-3R35-B | 1321-3RA35-B |
| 20BB042 | Heavy Duty | 10 | 1321-3R35-B | 1321-3RA35-B | 1321-3R45-B | 1321-3RA45-B |
| 20BB042 | Normal Duty | 15 | 1321-3R45-B | 1321-3RA45-B | 1321-3R45-B | 1321-3RA45-B |
| 20BB052 | Heavy Duty | 15 | 1321-3R45-B | 1321-3RA45-B | 1321-3R55-B | 1321-3RA55-B |
| 20BB052 | Normal Duty | 20 | 1321-3R55-B | 1321-3RA55-B | 1321-3R55-B | 1321-3RA55-B |
| 20BB070 | Heavy Duty | 20 | 1321-3R55-B | 1321-3RA55-B | 1321-3R80-B | 1321-3RA80-B |
| 20BB070 | Normal Duty | 25 | 1321-3R80-B | 1321-3RA80-B | 1321-3R80-B | 1321-3RA80-B |
| 20BB080 | Heavy Duty | 25 | 1321-3R80-B | 1321-3RA80-B | 1321-3R80-B | 1321-3RA80-B |
| 20BB080 | Normal Duty | 30 | 1321-3R80-B | 1321-3RA80-B | 1321-3R80-B | 1321-3RA80-B |
| 20BB104 | Heavy Duty | 30 | 1321-3R80-B | 1321-3RA80-B | 1321-3R80-B | 1321-3RA80-B |
| 20BB104 | Normal Duty | 40 | 1321-3R100-B | 1321-3RA100-B | 1321-3R100-B | 1321-3RA100-B |
| 20BB130 | Heavy Duty | 40 | 1321-3R100-B | 1321-3RA100-B | 1321-3R100-B | 1321-3RA100-B |
| 20BB130 | Normal Duty | 50 | 1321-3R130-B | 1321-3RA130-B | 1321-3R130-B | 1321-3RA130-B |
| 20BB154 | Heavy Duty | 50 | 1321-3R130-B | 1321-3RA130-B | 1321-3R130-B | 1321-3RA130-B |
| 20BB154 | Normal Duty | 60 | 1321-3R160-B | 1321-3RA160-B | 1321-3R160-B | 1321-3RA160-B |
| 20BB192 | Heavy Duty | 60 | 1321-3R160-B | 1321-3RA160-B | 1321-3R160-B | 1321-3RA160-B |
| 20BB192 | Normal Duty | 75 | 1321-3R200-B | 1321-3RA200-B | 1321-3R200-B | 1321-3RA200-B |
| 20BB260 | Heavy Duty | 75 | 1321-3R200-B | 1321-3RA200-B | 1321-3R200-B | 1321-3RA200-B |
| 20BB260 | Normal Duty | 100 | 1321-3RB250-B | 1321-3RAB250-B | 1321-3RB250-B | 1321-3RAB250-B |

(1) Input line reactors were sized based on the NEC fundamental motor amps. Output line reactors were sized based on the VFD rated output currents.

480V, 60 Hz, Three-Phase, 3% Impedance

| Drive Cat. No. | Duty | Hp | Input Line Reactor ⁽¹⁾ | | Output Line Reactor ⁽¹⁾ | |
|----------------|-------------|------|-----------------------------------|-----------------------|------------------------------------|-----------------------|
| | | | IP00 (Open Style) | IP11 (NEMA/UL Type 1) | IP00 (Open Style) | IP11 (NEMA/UL Type 1) |
| | | | Cat. No. | Cat. No. | Cat. No. | Cat. No. |
| 20BD1P1 | Heavy Duty | 0.33 | 1321-3R1-C | 1321-3RA1-C | 1321-3R2-B | 1321-3RA2-B |
| 20BD1P1 | Normal Duty | 0.5 | 1321-3R1-C | 1321-3RA1-C | 1321-3R2-B | 1321-3RA2-B |
| 20BD2P1 | Heavy Duty | 0.75 | 1321-3R2-A | 1321-3RA2-A | 1321-3R2-A | 1321-3RA2-A |
| 20BD2P1 | Normal Duty | 1 | 1321-3R2-A | 1321-3RA2-A | 1321-3R2-A | 1321-3RA2-A |
| 20BD3P4 | Heavy Duty | 1.5 | 1321-3R4-C | 1321-3RA4-C | 1321-3R4-B | 1321-3RA4-B |
| 20BD3P4 | Normal Duty | 2 | 1321-3R4-B | 1321-3RA4-B | 1321-3R4-B | 1321-3RA4-B |
| 20BD5P0 | Heavy Duty | 2 | 1321-3R4-B | 1321-3RA4-B | 1321-3R8-C | 1321-3RA8-C |
| 20BD5P0 | Normal Duty | 3 | 1321-3R8-C | 1321-3RA8-C | 1321-3R8-C | 1321-3RA8-C |
| 20BD8P0 | Heavy Duty | 3 | 1321-3R8-C | 1321-3RA8-C | 1321-3R8-B | 1321-3RA8-B |
| 20BD8P0 | Normal Duty | 5 | 1321-3R8-B | 1321-3RA8-B | 1321-3R8-B | 1321-3RA8-B |
| 20BD011 | Heavy Duty | 5 | 1321-3R8-B | 1321-3RA8-B | 1321-3R12-B | 1321-3RA12-B |
| 20BD011 | Normal Duty | 7.5 | 1321-3R12-B | 1321-3RA12-B | 1321-3R12-B | 1321-3RA12-B |
| 20BD014 | Heavy Duty | 7.5 | 1321-3R12-B | 1321-3RA12-B | 1321-3R18-B | 1321-3RA18-B |
| 20BD014 | Normal Duty | 10 | 1321-3R18-B | 1321-3RA18-B | 1321-3R18-B | 1321-3RA18-B |
| 20BD022 | Heavy Duty | 10 | 1321-3R18-B | 1321-3RA18-B | 1321-3R25-B | 1321-3RA25-B |
| 20BD022 | Normal Duty | 15 | 1321-3R25-B | 1321-3RA25-B | 1321-3R25-B | 1321-3RA25-B |
| 20BD027 | Heavy Duty | 15 | 1321-3R25-B | 1321-3RA25-B | 1321-3R25-B | 1321-3RA25-B |
| 20BD027 | Normal Duty | 20 | 1321-3R35-B | 1321-3RA35-B | 1321-3R25-B | 1321-3RA25-B |
| 20BD034 | Heavy Duty | 20 | 1321-3R35-B | 1321-3RA35-B | 1321-3R35-B | 1321-3RA35-B |
| 20BD034 | Normal Duty | 25 | 1321-3R35-B | 1321-3RA35-B | 1321-3R35-B | 1321-3RA35-B |
| 20BD040 | Heavy Duty | 25 | 1321-3R35-B | 1321-3RA35-B | 1321-3R45-B | 1321-3RA45-B |
| 20BD040 | Normal Duty | 30 | 1321-3R45-B | 1321-3RA45-B | 1321-3R45-B | 1321-3RA45-B |
| 20BD052 | Heavy Duty | 30 | 1321-3R45-B | 1321-3RA45-B | 1321-3R55-B | 1321-3RA55-B |
| 20BD052 | Normal Duty | 40 | 1321-3R55-B | 1321-3RA55-B | 1321-3R55-B | 1321-3RA55-B |
| 20BD065 | Heavy Duty | 40 | 1321-3R55-B | 1321-3RA55-B | 1321-3R80-B | 1321-3RA80-B |
| 20BD065 | Normal Duty | 50 | 1321-3R80-B | 1321-3RA80-B | 1321-3R80-B | 1321-3RA80-B |
| 20BD077 | Heavy Duty | 50 | 1321-3R80-B | 1321-3RA80-B | 1321-3R80-B | 1321-3RA80-B |
| 20BD077 | Normal Duty | 60 | 1321-3R80-B | 1321-3RA80-B | 1321-3R80-B | 1321-3RA80-B |
| 20BD096 | Heavy Duty | 60 | 1321-3R80-B | 1321-3RA80-B | 1321-3R80-B | 1321-3RA80-B |
| 20BD096 | Normal Duty | 75 | 1321-3R100-B | 1321-3RA100-B | 1321-3R100-B | 1321-3RA100-B |
| 20BD125 | Heavy Duty | 75 | 1321-3R100-B | 1321-3RA100-B | 1321-3R100-B | 1321-3RA100-B |
| 20BD125 | Normal Duty | 100 | 1321-3R130-B | 1321-3RA130-B | 1321-3R130-B | 1321-3RA130-B |
| 20BD156 | Heavy Duty | 100 | 1321-3R130-B | 1321-3RA130-B | 1321-3R130-B | 1321-3RA130-B |
| 20BD156 | Normal Duty | 125 | 1321-3R160-B | 1321-3RA160-B | 1321-3R160-B | 1321-3RA160-B |
| 20BD180 | Heavy Duty | 125 | 1321-3R160-B | 1321-3RA160-B | 1321-3R160-B | 1321-3RA160-B |
| 20BD180 | Normal Duty | 150 | 1321-3R200-B | 1321-3RA200-B | 1321-3R200-C | 1321-3RA200-C |

continued

| Drive Cat. No. | Duty | Hp | Input Line Reactor ⁽¹⁾ | | Output Line Reactor ⁽¹⁾ | |
|----------------|-------------|-----|-----------------------------------|-----------------------|------------------------------------|-----------------------|
| | | | IP00 (Open Style) | IP11 (NEMA/UL Type 1) | IP00 (Open Style) | IP11 (NEMA/UL Type 1) |
| | | | Cat. No. | Cat. No. | Cat. No. | Cat. No. |
| 20BD248 | Heavy Duty | 150 | 1321-3R200-B | 1321-3RA200-B | 1321-3R200-C | 1321-3RA200-C |
| 20BD248 | Normal Duty | 200 | 1321-3RB250-B | 1321-3RAB250-B | 1321-3RB250-B | 1321-3RAB250-B |
| 20BD292 | Heavy Duty | 200 | 1321-3RB250-B | 1321-3RAB250-B | 1321-3RB250-B | 1321-3RAB250-B |
| 20BD292 | Normal Duty | 250 | 1321-3RB320-B | 1321-3RAB320-B | 1321-3RB320-B | 1321-3RAB320-B |
| 20BD325 | Heavy Duty | 250 | 1321-3RB320-B | 1321-3RAB320-B | 1321-3RB320-B | 1321-3RAB320-B |
| 20BD325 | Normal Duty | 250 | 1321-3RB320-B | 1321-3RAB320-B | 1321-3RB320-B | 1321-3RAB320-B |
| 20BD365 | Heavy Duty | 250 | 1321-3RB320-B | 1321-3RAB320-B | 1321-3RB320-B | 1321-3RAB320-B |
| 20BD365 | Normal Duty | 300 | 1321-3RB400-B | 1321-3RAB400-B | 1321-3RB400-B | 1321-3RAB400-B |
| 20BD415 | Heavy Duty | 300 | 1321-3RB400-B | 1321-3RAB400-B | 1321-3RB400-B | 1321-3RAB400-B |
| 20BD415 | Normal Duty | 350 | 1321-3RB400-B | 1321-3RAB400-B | 1321-3RB400-B | 1321-3RAB400-B |
| 20BD481 | Heavy Duty | 350 | 1321-3RB400-B | 1321-3RAB400-B | 1321-3RB400-B | 1321-3RAB400-B |
| 20BD481 | Normal Duty | 400 | 1321-3R500-B | 1321-3RA500-B | 1321-3R500-B | 1321-3RA500-B |
| 20BD535 | Heavy Duty | 400 | 1321-3R500-B | 1321-3RA500-B | 1321-3R500-B | 1321-3RA500-B |
| 20BD535 | Normal Duty | 450 | 1321-3R500-B | 1321-3RA500-B | 1321-3R500-B | 1321-3RA500-B |
| 20BD600 | Heavy Duty | 450 | 1321-3R500-B | 1321-3RA500-B | 1321-3R500-B | 1321-3RA500-B |
| 20BD600 | Normal Duty | 500 | 1321-3R600-B | 1321-3RA600-B | 1321-3R600-B | 1321-3RA600-B |
| 20BD730 | Heavy Duty | 500 | 1321-3R600-B | 1321-3RA600-B | 1321-3R600-B | 1321-3RA600-B |
| 20BD730 | Normal Duty | 600 | 1321-3R750-B | 1321-3RA750-B | 1321-3R750-B | 1321-3RA750-B |
| 20BD875 | Heavy Duty | 600 | 1321-3R750-B | 1321-3RA750-B | 1321-3R600-B | 1321-3RA600-B |
| 20BD875 | Normal Duty | 700 | 1321-3R850-B | 1321-3RA850-B | 1321-3R850-B | 1321-3RA850-B |

(1) Input line reactors were sized based on the NEC fundamental motor amps. Output line reactors were sized based on the VFD rated output currents.

480V, 60 Hz, Three-Phase, 5% Impedance

| Drive Cat. No. | Duty | Hp | Input Line Reactor ⁽¹⁾ | | Output Line Reactor ⁽¹⁾ | |
|----------------|-------------|------|-----------------------------------|-----------------------------|------------------------------------|------------------------------|
| | | | IP00 (Open Style) | IP11 (NEMA/UL Type 1) | IP00 (Open Style) | IP11 (NEMA/UL Type 1) |
| | | | Cat. No. | Cat. No. | Cat. No. | Cat. No. |
| 20BD1P1 | Heavy Duty | 0.33 | 1321-3R1-B | 1321-3RA1-B | 1321-3R2-C | 1321-3RA2-C |
| 20BD1P1 | Normal Duty | 0.5 | 1321-3R1-B | 1321-3RA1-B | 1321-3R2-C | 1321-3RA2-C |
| 20BD2P1 | Heavy Duty | 0.75 | 1321-3R2-C | 1321-3RA2-C | 1321-3R2-B | 1321-3RA2-B |
| 20BD2P1 | Normal Duty | 1 | 1321-3R2-B | 1321-3RA2-B | 1321-3R2-B | 1321-3RA2-B |
| 20BD3P4 | Heavy Duty | 1.5 | 1321-3R4-D | 1321-3RA4-D | 1321-3R4-D | 1321-3RA4-D |
| 20BD3P4 | Normal Duty | 2 | 1321-3R4-D | 1321-3RA4-D | 1321-3R4-D | 1321-3RA4-D |
| 20BD5P0 | Heavy Duty | 2 | 1321-3R4-D | 1321-3RA4-D | 1321-3R8-D | 1321-3RA8-D |
| 20BD5P0 | Normal Duty | 3 | 1321-3R8-D | 1321-3RA8-D | 1321-3R8-D | 1321-3RA8-D |
| 20BD8P0 | Heavy Duty | 3 | 1321-3R8-D | 1321-3RA8-D | 1321-3R8-C | 1321-3RA8-C |
| 20BD8P0 | Normal Duty | 5 | 1321-3R8-C | 1321-3RA8-C | 1321-3R8-C | 1321-3RA8-C |
| 20BD011 | Heavy Duty | 5 | 1321-3R8-C | 1321-3RA8-C | 1321-3R12-C | 1321-3RA12-C |
| 20BD011 | Normal Duty | 7.5 | 1321-3R12-C | 1321-3RA12-C | 1321-3R12-C | 1321-3RA12-C |
| 20BD014 | Heavy Duty | 7.5 | 1321-3R12-C | 1321-3RA12-C | 1321-3R18-C | 1321-3RA18-C |
| 20BD014 | Normal Duty | 10 | 1321-3R18-C | 1321-3RA18-C | 1321-3R18-C | 1321-3RA18-C |
| 20BD022 | Heavy Duty | 10 | 1321-3R18-C | 1321-3RA18-C | 1321-3R25-C | 1321-3RA25-C |
| 20BD022 | Normal Duty | 15 | 1321-3R25-C | 1321-3RA25-C | 1321-3R25-C | 1321-3RA25-C |
| 20BD027 | Heavy Duty | 15 | 1321-3R25-C | 1321-3RA25-C | 1321-3R25-C | 1321-3RA25-C |
| 20BD027 | Normal Duty | 20 | 1321-3R35-C ⁽²⁾ | 1321-3RA35-C ⁽²⁾ | 1321-3R25-C | 1321-3RA25-C |
| 20BD034 | Heavy Duty | 20 | 1321-3R35-C ⁽²⁾ | 1321-3RA35-C ⁽²⁾ | 1321-3R35-C | 1321-3RA35-C |
| 20BD034 | Normal Duty | 25 | 1321-3R35-C | 1321-3RA35-C | 1321-3R35-C | 1321-3RA35-C |
| 20BD040 | Heavy Duty | 25 | 1321-3R35-C | 1321-3RA35-C | 1321-3R45-C | 1321-3RA45-C |
| 20BD040 | Normal Duty | 30 | 1321-3R45-C | 1321-3RA45-C | 1321-3R45-C | 1321-3RA45-C |
| 20BD052 | Heavy Duty | 30 | 1321-3R45-C | 1321-3RA45-C | 1321-3R55-C | 1321-3RA55-C |
| 20BD052 | Normal Duty | 40 | 1321-3R55-C | 1321-3RA55-C | 1321-3R55-C | 1321-3RA55-C |
| 20BD065 | Heavy Duty | 40 | 1321-3R55-C | 1321-3RA55-C | 1321-3R80-C | 1321-3RA80-C |
| 20BD065 | Normal Duty | 50 | 1321-3R80-C | 1321-3RA80-C | 1321-3R80-C | 1321-3RA80-C |
| 20BD077 | Heavy Duty | 50 | 1321-3R80-C | 1321-3RA80-C | 1321-3R80-C | 1321-3RA80-C |
| 20BD077 | Normal Duty | 60 | 1321-3R80-C | 1321-3RA80-C | 1321-3R80-C | 1321-3RA80-C |
| 20BD096 | Heavy Duty | 60 | 1321-3R80-C | 1321-3RA80-C | 1321-3R80-C | 1321-3RA80-C |
| 20BD096 | Normal Duty | 75 | 1321-3R100-C | 1321-3RA100-C | 1321-3R100-C | 1321-3RA100-C |
| 20BD125 | Heavy Duty | 75 | 1321-3R100-C | 1321-3RA100-C | 1321-3R100-C | 1321-3RA100-C |
| 20BD125 | Normal Duty | 100 | 1321-3R130-C | 1321-3RA130-C | 1321-3R130-C | 1321-3RA130-C |
| 20BD156 | Heavy Duty | 100 | 1321-3R130-C | 1321-3RA130-C | 1321-3R130-C | 1321-3RA130-C |
| 20BD156 | Normal Duty | 125 | 1321-3R160-C | 1321-3RA160-C | 1321-3R160-C | 1321-3RA160-C |
| 20BD180 | Heavy Duty | 125 | 1321-3R160-C | 1321-3RA160-C | 1321-3R160-C | 1321-3RA160-C |
| 20BD180 | Normal Duty | 150 | 1321-3R200-C | 1321-3RA200-C | 1321-3R200-C ⁽²⁾ | 1321-3RA200-C ⁽²⁾ |

continued

| Drive Cat. No. | Duty | Hp | Input Line Reactor ⁽¹⁾ | | Output Line Reactor ⁽¹⁾ | |
|----------------|-------------|-----|-----------------------------------|-----------------------|------------------------------------|------------------------------|
| | | | IP00 (Open Style) | IP11 (NEMA/UL Type 1) | IP00 (Open Style) | IP11 (NEMA/UL Type 1) |
| | | | Cat. No. | Cat. No. | Cat. No. | Cat. No. |
| 20BD248 | Heavy Duty | 150 | 1321-3R200-C | 1321-3RA200-C | 1321-3R200-C ⁽²⁾ | 1321-3RA200-C ⁽²⁾ |
| 20BD248 | Normal Duty | 200 | 1321-3RB250-C | 1321-3RAB250-C | 1321-3RB250-C | 1321-3RAB250-C |
| 20BD292 | Heavy Duty | 200 | 1321-3RB250-C | 1321-3RAB250-C | 1321-3RB250-C | 1321-3RAB250-C |
| 20BD292 | Normal Duty | 250 | 1321-3RB320-C | 1321-3RAB320-C | 1321-3RB320-C | 1321-3RAB320-C |
| 20BD325 | Heavy Duty | 250 | 1321-3RB320-C | 1321-3RAB320-C | 1321-3RB320-C | 1321-3RAB320-C |
| 20BD325 | Normal Duty | 250 | 1321-3RB320-C | 1321-3RAB320-C | 1321-3RB320-C | 1321-3RAB320-C |
| 20BD365 | Heavy Duty | 250 | 1321-3RB320-C | 1321-3RAB320-C | 1321-3RB320-C | 1321-3RAB320-C |
| 20BD365 | Normal Duty | 300 | 1321-3RB400-C | 1321-3RAB400-C | 1321-3RB400-C | 1321-3RAB400-C |
| 20BD415 | Heavy Duty | 300 | 1321-3RB400-C | 1321-3RAB400-C | 1321-3RB400-C | 1321-3RAB400-C |
| 20BD415 | Normal Duty | 350 | 1321-3R500-C | 1321-3RA500-C | 1321-3RB400-C | 1321-3RAB400-C |
| 20BD481 | Heavy Duty | 350 | 1321-3R500-C | 1321-3RA500-C | 1321-3RB400-C | 1321-3RAB400-C |
| 20BD481 | Normal Duty | 400 | 1321-3R500-C | 1321-3RA500-C | 1321-3R500-C | 1321-3RA500-C |
| 20BD535 | Heavy Duty | 400 | 1321-3R500-C | 1321-3RA500-C | 1321-3R500-C | 1321-3RA500-C |
| 20BD535 | Normal Duty | 450 | 1321-3R600-C | 1321-3RA600-C | 1321-3R500-C | 1321-3RA500-C |
| 20BD600 | Heavy Duty | 450 | 1321-3R600-C | 1321-3RA600-C | 1321-3R500-C | 1321-3RA500-C |
| 20BD600 | Normal Duty | 500 | 1321-3R600-C | 1321-3RA600-C | 1321-3R600-C | 1321-3RA600-C |
| 20BD730 | Heavy Duty | 500 | 1321-3R600-C | 1321-3RA600-C | 1321-3R600-C | 1321-3RA600-C |
| 20BD730 | Normal Duty | 600 | 1321-3R750-E | 1321-3RA750-E | 1321-3R750-E | 1321-3RA750-E |
| 20BD875 | Heavy Duty | 600 | 1321-3R750-E | 1321-3RA750-E | 1321-3R750-E | 1321-3RA750-E |
| 20BD875 | Normal Duty | 700 | 1321-3R850-C | 1321-3RA850-C | 1321-3R850-C | 1321-3RA850-C |

(1) Input line reactors were sized based on the NEC fundamental motor amps. Output line reactors were sized based on the VFD rated output currents.

(2) 4% impedance.

600V, 60 Hz, Three-Phase, 3% Impedance

| Drive Cat. No. | Duty | Hp | Input Line Reactor ⁽¹⁾ | | Output Line Reactor ⁽¹⁾ | |
|----------------|-------------|-----|-----------------------------------|-----------------------|------------------------------------|-----------------------|
| | | | IP00 (Open Style) | IP11 (NEMA/UL Type 1) | IP00 (Open Style) | IP11 (NEMA/UL Type 1) |
| | | | Cat. No. | Cat. No. | Cat. No. | Cat. No. |
| 20BE1P7 | Heavy Duty | 0.5 | 1321-3R1-C | 1321-3RA1-C | 1321-3R2-B | 1321-3RA2-B |
| 20BE1P7 | Normal Duty | 1 | 1321-3R2-B | 1321-3RA2-B | 1321-3R2-B | 1321-3RA2-B |
| 20BE2P7 | Heavy Duty | 1 | 1321-3R2-B | 1321-3RA2-B | 1321-3R4-D | 1321-3RA4-D |
| 20BE2P7 | Normal Duty | 2 | 1321-3R4-D | 1321-3RA4-D | 1321-3R4-D | 1321-3RA4-D |
| 20BE3P9 | Heavy Duty | 2 | 1321-3R4-D | 1321-3RA4-D | 1321-3R4-C | 1321-3RA4-C |
| 20BE3P9 | Normal Duty | 3 | 1321-3R4-C | 1321-3RA4-C | 1321-3R4-C | 1321-3RA4-C |
| 20BE6P1 | Heavy Duty | 3 | 1321-3R4-C | 1321-3RA4-C | 1321-3R8-C | 1321-3RA8-C |
| 20BE6P1 | Normal Duty | 5 | 1321-3R8-C | 1321-3RA8-C | 1321-3R8-C | 1321-3RA8-C |
| 20BE9P0 | Heavy Duty | 5 | 1321-3R8-C | 1321-3RA8-C | 1321-3R12-C | 1321-3RA12-C |
| 20BE9P0 | Normal Duty | 7.5 | 1321-3R12-C | 1321-3RA12-C | 1321-3R12-C | 1321-3RA12-C |
| 20BE011 | Heavy Duty | 7.5 | 1321-3R12-C | 1321-3RA12-C | 1321-3R12-B | 1321-3RA12-B |
| 20BE011 | Normal Duty | 10 | 1321-3R12-B | 1321-3RA12-B | 1321-3R12-B | 1321-3RA12-B |
| 20BE017 | Heavy Duty | 10 | 1321-3R12-B | 1321-3RA12-B | 1321-3R18-B | 1321-3RA18-B |
| 20BE017 | Normal Duty | 15 | 1321-3R18-B | 1321-3RA18-B | 1321-3R18-B | 1321-3RA18-B |
| 20BE022 | Heavy Duty | 15 | 1321-3R18-B | 1321-3RA18-B | 1321-3R25-B | 1321-3RA25-B |
| 20BE022 | Normal Duty | 20 | 1321-3R25-B | 1321-3RA25-B | 1321-3R25-B | 1321-3RA25-B |
| 20BE027 | Heavy Duty | 20 | 1321-3R25-B | 1321-3RA25-B | 1321-3R35-C | 1321-3RA35-C |
| 20BE027 | Normal Duty | 25 | 1321-3R35-C | 1321-3RA35-C | 1321-3R35-C | 1321-3RA35-C |
| 20BE032 | Heavy Duty | 25 | 1321-3R35-C | 1321-3RA35-C | 1321-3R35-B | 1321-3RA35-B |
| 20BE032 | Normal Duty | 30 | 1321-3R35-B | 1321-3RA35-B | 1321-3R35-B | 1321-3RA35-B |
| 20BE041 | Heavy Duty | 30 | 1321-3R35-B | 1321-3RA35-B | 1321-3R45-B | 1321-3RA45-B |
| 20BE041 | Normal Duty | 40 | 1321-3R45-B | 1321-3RA45-B | 1321-3R45-B | 1321-3RA45-B |
| 20BE052 | Heavy Duty | 40 | 1321-3R45-B | 1321-3RA45-B | 1321-3R55-B | 1321-3RA55-B |
| 20BE052 | Normal Duty | 50 | 1321-3R55-B | 1321-3RA55-B | 1321-3R55-B | 1321-3RA55-B |
| 20BE062 | Heavy Duty | 50 | 1321-3R55-B | 1321-3RA55-B | 1321-3R80-B | 1321-3RA80-B |
| 20BE062 | Normal Duty | 60 | 1321-3R80-B | 1321-3RA80-B | 1321-3R80-B | 1321-3RA80-B |
| 20BE077 | Heavy Duty | 60 | 1321-3R80-B | 1321-3RA80-B | 1321-3R80-B | 1321-3RA80-B |
| 20BE077 | Normal Duty | 75 | 1321-3R80-B | 1321-3RA80-B | 1321-3R80-B | 1321-3RA80-B |
| 20BE099 | Heavy Duty | 75 | 1321-3R80-B | 1321-3RA80-B | 1321-3R80-B | 1321-3RA80-B |
| 20BE099 | Normal Duty | 100 | 1321-3R100-B | 1321-3RA100-B | 1321-3R100-B | 1321-3RA100-B |
| 20BE125 | Heavy Duty | 100 | 1321-3R100-B | 1321-3RA100-B | 1321-3R100-B | 1321-3RA100-B |
| 20BE125 | Normal Duty | 125 | 1321-3R130-B | 1321-3RA130-B | 1321-3R130-B | 1321-3RA130-B |
| 20BE144 | Heavy Duty | 125 | 1321-3R130-B | 1321-3RA130-B | 1321-3R130-B | 1321-3RA130-B |
| 20BE144 | Normal Duty | 150 | 1321-3R160-B | 1321-3RA160-B | 1321-3R160-B | 1321-3RA160-B |

(1) Input line reactors were sized based on the NEC fundamental motor amps. Output line reactors were sized based on the VFD rated output currents.

600V, 60 Hz, Three-Phase, 5% Impedance

| Drive Cat. No. | Duty | Hp | Input Line Reactor ⁽¹⁾ | | Output Line Reactor ⁽¹⁾ | |
|----------------|-------------|-----|-----------------------------------|------------------------------|------------------------------------|------------------------------|
| | | | IP00 (Open Style) | IP11 (NEMA/UL Type 1) | IP00 (Open Style) | IP11 (NEMA/UL Type 1) |
| | | | Cat. No. | Cat. No. | Cat. No. | Cat. No. |
| 20BE1P7 | Heavy Duty | 0.5 | 1321-3R1-B | 1321-3RA1-B | 1321-3R2-C | 1321-3RA2-C |
| 20BE1P7 | Normal Duty | 1 | 1321-3R2-C | 1321-3RA2-C | 1321-3R2-C | 1321-3RA2-C |
| 20BE2P7 | Heavy Duty | 1 | 1321-3R2-C | 1321-3RA2-C | 1321-3R4-D ⁽²⁾ | 1321-3RA4-D ⁽²⁾ |
| 20BE2P7 | Normal Duty | 2 | 1321-3R4-D ⁽²⁾ | 1321-3RA4-D ⁽²⁾ | 1321-3R4-D ⁽²⁾ | 1321-3RA4-D ⁽²⁾ |
| 20BE3P9 | Heavy Duty | 2 | 1321-3R4-D ⁽²⁾ | 1321-3RA4-D ⁽²⁾ | 1321-3R4-D | 1321-3RA4-D |
| 20BE3P9 | Normal Duty | 3 | 1321-3R4-D | 1321-3RA4-D | 1321-3R4-D | 1321-3RA4-D |
| 20BE6P1 | Heavy Duty | 3 | 1321-3R4-D | 1321-3RA4-D | 1321-3R8-D | 1321-3RA8-D |
| 20BE6P1 | Normal Duty | 5 | 1321-3R8-D | 1321-3RA8-D | 1321-3R8-D | 1321-3RA8-D |
| 20BE9P0 | Heavy Duty | 5 | 1321-3R8-D | 1321-3RA8-D | 1321-3R12-C ⁽²⁾ | 1321-3RA12-C ⁽²⁾ |
| 20BE9P0 | Normal Duty | 7.5 | 1321-3R12-C ⁽²⁾ | 1321-3RA12-C ⁽²⁾ | 1321-3R12-C ⁽²⁾ | 1321-3RA12-C ⁽²⁾ |
| 20BE011 | Heavy Duty | 7.5 | 1321-3R12-C ⁽²⁾ | 1321-3RA12-C ⁽²⁾ | 1321-3R12-C | 1321-3RA12-C |
| 20BE011 | Normal Duty | 10 | 1321-3R12-C | 1321-3RA12-C | 1321-3R12-C | 1321-3RA12-C |
| 20BE017 | Heavy Duty | 10 | 1321-3R12-C | 1321-3RA12-C | 1321-3R18-C | 1321-3RA18-C |
| 20BE017 | Normal Duty | 15 | 1321-3R18-C | 1321-3RA18-C | 1321-3R18-C | 1321-3RA18-C |
| 20BE022 | Heavy Duty | 15 | 1321-3R18-C | 1321-3RA18-C | 1321-3R25-C ⁽²⁾ | 1321-3RA25-C ⁽²⁾ |
| 20BE022 | Normal Duty | 20 | 1321-3R25-C ⁽²⁾ | 1321-3RA25-C ⁽²⁾ | 1321-3R25-C ⁽²⁾ | 1321-3RA25-C ⁽²⁾ |
| 20BE027 | Heavy Duty | 20 | 1321-3R25-C ⁽²⁾ | 1321-3RA25-C ⁽²⁾ | 1321-3R35-C ⁽²⁾ | 1321-3RA35-C ⁽²⁾ |
| 20BE027 | Normal Duty | 25 | 1321-3R35-C ⁽²⁾ | 1321-3RA35-C ⁽²⁾ | 1321-3R35-C ⁽²⁾ | 1321-3RA35-C ⁽²⁾ |
| 20BE032 | Heavy Duty | 25 | 1321-3R35-C ⁽²⁾ | 1321-3RA35-C ⁽²⁾ | 1321-3R35-C ⁽²⁾ | 1321-3RA35-C ⁽²⁾ |
| 20BE032 | Normal Duty | 30 | 1321-3R35-C ⁽²⁾ | 1321-3RA35-C ⁽²⁾ | 1321-3R35-C ⁽²⁾ | 1321-3RA35-C ⁽²⁾ |
| 20BE041 | Heavy Duty | 30 | 1321-3R35-C ⁽²⁾ | 1321-3RA35-C ⁽²⁾ | 1321-3R45-C | 1321-3RA45-C |
| 20BE041 | Normal Duty | 40 | 1321-3R45-C | 1321-3RA45-C | 1321-3R45-C | 1321-3RA45-C |
| 20BE052 | Heavy Duty | 40 | 1321-3R45-C | 1321-3RA45-C | 1321-3R55-C | 1321-3RA55-C |
| 20BE052 | Normal Duty | 50 | 1321-3R55-C | 1321-3RA55-C | 1321-3R55-C | 1321-3RA55-C |
| 20BE062 | Heavy Duty | 50 | 1321-3R55-C | 1321-3RA55-C | 1321-3R80-C | 1321-3RA80-C |
| 20BE062 | Normal Duty | 60 | 1321-3R80-C | 1321-3RA80-C | 1321-3R80-C | 1321-3RA80-C |
| 20BE077 | Heavy Duty | 60 | 1321-3R80-C | 1321-3RA80-C | 1321-3R80-C | 1321-3RA80-C |
| 20BE077 | Normal Duty | 75 | 1321-3R80-C | 1321-3RA80-C | 1321-3R80-C | 1321-3RA80-C |
| 20BE099 | Heavy Duty | 75 | 1321-3R80-C | 1321-3RA80-C | 1321-3R80-C | 1321-3RA80-C |
| 20BE099 | Normal Duty | 100 | 1321-3R100-C | 1321-3RA100-C | 1321-3R100-C | 1321-3RA100-C |
| 20BE125 | Heavy Duty | 100 | 1321-3R100-C | 1321-3RA100-C | 1321-3R100-C | 1321-3RA100-C |
| 20BE125 | Normal Duty | 125 | 1321-3R130-C ⁽²⁾ | 1321-3RA130-C ⁽²⁾ | 1321-3R130-C ⁽²⁾ | 1321-3RA130-C ⁽²⁾ |
| 20BE144 | Heavy Duty | 125 | 1321-3R130-C ⁽²⁾ | 1321-3RA130-C ⁽²⁾ | 1321-3R130-C ⁽²⁾ | 1321-3RA130-C ⁽²⁾ |
| 20BE144 | Normal Duty | 150 | 1321-3R160-C ⁽²⁾ | 1321-3RA160-C ⁽²⁾ | 1321-3R160-C ⁽²⁾ | 1321-3RA160-C ⁽²⁾ |

(1) Input line reactors were sized based on the NEC fundamental motor amps. Output line reactors were sized based on the VFD rated output currents.

(2) 4% impedance.

Important User Information

Read this document and the documents listed in the additional resources section about installation, configuration, and operation of this equipment before you install, configure, operate, or maintain this product. Users are required to familiarize themselves with installation and wiring instructions in addition to requirements of all applicable codes, laws, and standards.

Activities including installation, adjustments, putting into service, use, assembly, disassembly, and maintenance are required to be carried out by suitably trained personnel in accordance with applicable code of practice.

If this equipment is used in a manner not specified by the manufacturer, the protection provided by the equipment may be impaired.

In no event will Rockwell Automation, Inc. be responsible or liable for indirect or consequential damages resulting from the use or application of this equipment.

The examples and diagrams in this manual are included solely for illustrative purposes. Because of the many variables and requirements associated with any particular installation, Rockwell Automation, Inc. cannot assume responsibility or liability for actual use based on the examples and diagrams.

No patent liability is assumed by Rockwell Automation, Inc. with respect to use of information, circuits, equipment, or software described in this manual.

Reproduction of the contents of this manual, in whole or in part, without written permission of Rockwell Automation, Inc., is prohibited.

Documentation Feedback

Your comments will help us serve your documentation needs better. If you have any suggestions on how to improve this document, complete this form, publication [RA-DU002](#), available at <http://www.rockwellautomation.com/literature/>.

Allen-Bradley, Rockwell Software, Rockwell Automation, and LISTEN. THINK. SOLVE are trademarks of Rockwell Automation, Inc.
Trademarks not belonging to Rockwell Automation are property of their respective companies.

Rockwell Otomasyon Ticaret A.Ş., Kar Plaza İş Merkezi E Blok Kat:6 34752 İçerenköy, İstanbul, Tel: +90 (216) 5698400

www.rockwellautomation.com

Power, Control and Information Solutions Headquarters

Americas: Rockwell Automation, 1201 South Second Street, Milwaukee, WI 53204-2496 USA, Tel: (1) 414.382.2000, Fax: (1) 414.382.4444
Europe/Middle East/Africa: Rockwell Automation NV, Pegasus Park, De Kleetlaan 12a, 1831 Diegem, Belgium, Tel: (32) 2 663 0600, Fax: (32) 2 663 0640
Asia Pacific: Rockwell Automation, Level 14, Core F, Cyberport 3, 100 Cyberport Road, Hong Kong, Tel: (852) 2887 4788, Fax: (852) 2508 1846

Publication 20B-TD001G-EN-P - July 2013

Supersedes Publication 20B-TD001F-EN-P - July 2009

Copyright © 2013 Rockwell Automation, Inc. All rights reserved. Printed in the U.S.A.